



**2024**  
**2025**



# LEUCHTENKATALOG

 **LIGHTING CATALOGUE**

Stand: 01.04.2024

**ATEX-Leuchten | Handleuchten | Maschinenleuchten | Akku-Leuchten**  
***ATEX lighting | hand lamps | machine lights | rechargeable lights | torches***

Innovation  
Zuverlässigkeit  
Arbeitsleuchten  
Handleuchten  
Fairness  
Led  
AteX  
Werte  
Taschenlampen  
Lampen  
Maschinenleuchten  
Entwicklung  
Nachhaltigkeit  
Druckwasserdicht  
Transformatoren  
Flexibilität  
Leuchtstofflampen  
Beleuchtungswagen  
Beleuchtung  
Sicherheit  
Qualität  
Explosionsschutz  
Kompetenz  
Wassergeschützt  
Handscheinwerfer  
Service  
Umwelt

**Ideen**

**mit Licht...**

## **Made in Germany dafür stehen die Produkte der KIRA Leuchten GmbH**

Unsere Firma wurde 1949 gegründet. Sie ist heute ein Unternehmen mit hohem Know-How und in Fachkreisen im In- und Ausland als zuverlässige Partnerin mit ihrem Namen und ihren Produkten bekannt. Durch langjährige Erfahrungen im Bereich technischer Leuchten für die Industrie und das Handwerk können wir Ihnen mit präziser, individueller Entwicklung und Fertigung mit höchstem Qualitätsstandard Lösungen anbieten.

### **Seit November 2002 ist unser Unternehmen nach ISO 9001 und nach Ex-Schutzrichtlinien zertifiziert.**

Im Jahre 2011 wurde die Entwicklung und Herstellung von Vorschaltgeräten in den bestehenden Produktionsprozess eingegliedert. Der technische Fokus sowie die jahrzehntelangen Erfahrungen liegen in der Entwicklung elektronischer Geräte für verschiedene Beleuchtungseinheiten. Dies bietet Ihnen eine solide Grundlage für die Qualität der Leuchten.

## **Made in Germany – that's what the KIRA products stand for!**

Our company was founded in 1949. In the international industry, we are renowned as a reliable player owing to proven products and sustainable record. Backed with vast experience, we are capable to provide our clients with customized solutions and cutting edge quality.

### **Since November 2002 we are ISO 9001 and explosion-proof standard certified.**

In 2011 we have integrated development and production of ballasts in our value chain. The development of electronic devices for various illumination applications have always been the stringent target. Meanwhile, we pride ourselves with decades of experience which fosters the quality of our lamps. Customized self-ballasted lamps can easily be realized upon request.



...**seit 1949!**



LED HANDLEUCHTEN   LED HAND LAMPS	5 - 19
TRANSFORMATOREN   TRANSFORMERS	20
LED ROHRLEUCHTEN   LED TUBE LUMINAIRES	21 - 41
ZUBEHÖR   ACCESSORIES	42
ARBEITSPLATZLEUCHTEN   WORKPLACE LIGHTS	43 - 51
UV-A LED LEUCHTEN   UV-A LED LAMPS	52 - 53
LED AKKU-HANDSCHEINWERFER   LED RECHARGEABLE HAND LAMP	55 - 58

 **ATEX PRODUKTE | ATEX PRODUCTS**

LED HANDLEUCHTEN   LED HAND LAMPS	59 - 67
EX TROLLEY / EX STRAHLER / EX KOMPLETT-SETS   EX TROLLEY / EX FLOODLIGHT / EX COMPLETE SETS	68 - 72
LED ROHRLEUCHTEN   LED TUBE LUMINAIRES	73 - 83
ZUBEHÖR   ACCESSORIES	84
LED AKKU LEUCHTEN & TASCHENLAMPEN   LED RECHARGEABLE LIGHTS & TORCHES	85 - 95
GLOSSAR   GLOSSARY	96 - 98

**SYMBOLE | SYMBOLS**

 **XX POWER LED**  
Anzahl & Art der LED Module  
Number & type of the LED modules

 **Schutzklasse II bzw. III**  
Protection class II or III

 **E27 LED**  
LED E27 Leuchtmittel  
LED E27 Lamp

 **Symbol für ex-geschützte Leuchten**  
Symbolic identification for ex-proof lampsen

 **230V  
110V  
42V  
24V  
12V**  
Anschlussspannung  
Supply voltage

 **Kennzeichnung für Leuchten mit Akku-Betrieb**  
Identification for lamps with accu operation

 **IPxx**  
IP Schutzgrad  
IP protection category

 **Kennzeichnung für Leuchten mit Batterie-Betrieb**  
Identification for lamps with battery operation

 **H0x RN-F H07 BQ-F**  
Kabelspezifikation  
Cable specification

# KIRA LED Handleuchten - Einsatzgebiete

## *KIRA LED hand lamps - areas of application*



**KFZ Werkstätten**  
*automotive workshop*



**Schiffswerften**  
*shipyard*



**Industrieanlagen**  
*industrial plants*



**Eisenbahnindustrie**  
*rail industry*



**Spezialanwendungen**  
*special applications*



**Tankreinigung**  
*tank cleaning*



**Katastrophenschutz**  
*civil protection*



# KE-LED 3003-P | LED HANDLEUCHE | LED HAND LAMP

## Merkmale | Features

3x  
POWER  
LED

230V  
110V  
24V

IP54  
IP65

H05  
RN-F



Metallhaken, drehbar  
*metall hook, rotatable*

3x POWER LEDs | 5000K  
*3x POWER LEDs | 5000K*

Polycarbonat Schutzrohr  
*polycarbonate protective tube*

Diffusorfolie integriert  
*integrated diffuser film*

PVC Handgriff & Endkappe  
*PVC handle & end cap*

Zuleitung H05RN-F  
*cable H05RN-F*



## VORTEILE | ADVANTAGES

- kompakte, kurze Bauform
- geringes Gewicht
- *compact short design*
- *low weight*

## EINSATZBEREICHE | AREAS OF APPLICATION

- Inspektions- & Servicearbeiten
- KFZ-Werkstätten
- *inspection and service work*
- *car workshops*



# KE-LED 3003-P | LED HANDLEUCHE | LED HAND LAMP



**LED-Handleuchte, aufgrund kurzer Bauform ideal für den Werkzeugkasten geeignet. Blendfreies Licht dank speziellem Prismenschutzrohr.**

- Leuchtmittel: 3 POWER LEDs / 5000K
- Schutzrohr: Polycarbonat, schlagfest, 30mm Ø
- Handgriff / Abschlusskappe: PVC, schwarz
- Metallhaken: ja, drehbar
- Schutzart: IP54 (IP65 auf Anfrage)
- Schutzklasse: II bzw. III
- Zuleitung: 5m H05RN-F 2 x 1,00mm<sup>2</sup>
- Spannungsvarianten: 230V / 110V / 24V
- Längere Zuleitung, Kabeltyp, Stecker etc. auf Anfrage



**LED hand lamp, due to short structural shape ideal for the tool box. Dazzle-free light based on special prismatic-shaped protection tube.**

- Illuminant: 3 POWER LEDs / 5000K
- Protective tube: polycarbonate, 30mm Ø
- Handle / end cap: PVC, black
- Metal hook: yes, rotatable
- Protection category: IP54 (IP65 on request)
- Protection class: II resp. III
- Cable: 5m H05RN-F 2 x 1,00mm<sup>2</sup>
- Voltage variants: 230V / 110V / 24V
- Longer cable, cable type, plug etc. on request

## TECHNISCHE DATEN | TECHNICAL DATA

Art.-Nr.   Art.-No.	131330	131331	131317
Nennspannung   Nominal voltage	220-240V AC	110V AC/DC	24V AC/DC (12-24V)
Strom   Current	0,03 A	0,035 A	0,12 A
Schutzklasse   Protection class	II	II	III
Anzahl LED   Number LED	3	3	3
Leistung   Power	3,5 W	3,5 W	3,5 W
Nutzlicht   Real lumen	250 Lm	240 Lm	250 Lm
Leuchte Energieeffizienzklasse Luminaire energy efficiency class			
Farbtemperatur   Color temperature	5000 K		
Farbwiedergabe   Color rendering	> 80		
Lebensdauer LED   Lifetime LED	> 50.000 h		
Umgebungstemp.   Ambient temp.	-20°C - +40°C		
IP Schutzart   IP protection class	IP54 (IP65 optional)		
Diffusor   Diffuser	ja   yes		
Schutzrohr   Protective tube	Polycarbonat		
Handgriff / Kappe   Handle / End cap	PVC		
Zuleitung   Cable	5m H05RN-F 2 x 1,00mm <sup>2</sup>		
Stecker   Plug	230V Version: ja   yes (110V / 24V optional)		

## ABMESSUNGEN | DIMENSIONS (IN MM)

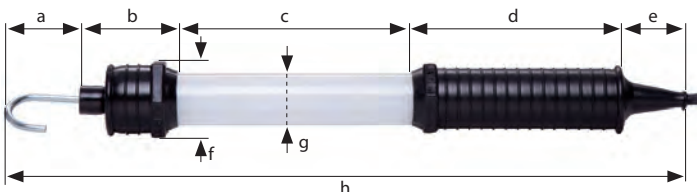

a	b	c	d	e	f	g	h
45	55	135	115	40	45	30	390

Gewicht | Weight: ca. 0,5kg

## ZUBEHÖR | ACCESSORIES



# KE-LED 3006-P | LED HANDLEUCHE | LED HAND LAMP

## Merkmale | Features

6x  
POWER  
LED

230V  
110V  
42V  
24V  
12V

IP54  
IP65

H05  
RN-F



Metallhaken, drehbar  
*metall hook, rotatable*

6x POWER LEDs | 5000K  
6x POWER LEDs | 5000K

Polycarbonat Schutzrohr  
*polycarbonate protective tube*

Diffusorfolie integriert  
*integrated diffuser film*

PVC Handgriff & Endkappe  
*PVC handle & end cap*

Zuleitung H05RN-F  
*cable H05RN-F*



## VORTEILE | ADVANTAGES

- hohe Lichtleistung trotz schlanker Bauform
- robustes, schlagfestes Polycarbonatrohr
- homogenes und blendfreies Licht
- *high light output despite slim design*
- *robust, impact-resistant polycarbonate tube*
- *homogeneous and glare-free light*

## EINSATZBEREICHE | AREAS OF APPLICATION

- Inspektions- & Servicearbeiten
- Industrie-Werkstätten
- KFZ-Werkstätten
- *inspection and service work*
- *industrial workshops*
- *car workshops*



# KE-LED 3006-P | LED HANDLEUCHTE | LED HAND LAMP



## Zuverlässige und robuste Inspektionsleuchte mit schlanker Bauform und homogenen Arbeitslicht.

- Leuchtmittel: 6 POWER LEDs / 5000K
- Schutzrohr: Polycarbonat, schlagfest, 30mm Ø
- Handgriff / Abschlusskappe: PVC, schwarz
- Metallhaken: ja, drehbar
- Schutzart: IP54 (IP65 auf Anfrage)
- Schutzklasse: II bzw. III
- Zuleitung: 5m H05RN-F 2 x 1,00mm<sup>2</sup>
- Spannungsvarianten: 230V / 110V / 42V / 24V / 12V
- Längere Zuleitung, Kabeltyp, Stecker etc. auf Anfrage



## Reliable and robust inspection light with a slim design and homogeneous working light.

- Illuminant: 6 POWER LEDs / 5000K
- Protective tube: polycarbonate, 30mm Ø
- Handle / end cap: PVC, black
- Metal hook: yes, rotatable
- Protection category: IP54 (IP65 on request)
- Protection class: II resp. III
- Cable: 5m H05RN-F 2 x 1,00mm<sup>2</sup>
- Voltage variants: 230V / 110V / 42V / 24V / 12V
- Longer cable, cable type, plug etc. on request

### TECHNISCHE DATEN | TECHNICAL DATA

Art.-Nr.   Art.-No.	131466	131467	131468	131469	131470
Nennspannung   Nominal voltage	220-240V AC	110V AC/DC	42V AC/DC	24V AC/DC	12V AC/DC
Strom   Current	0,035 A	0,06 A	0,12 A	0,21 A	0,275 A
Schutzklasse   Protection class	II	II	III	III	III
Anzahl LED   Number LED	6	6	6	6	6
Leistung   Power	5 W	5,7 W	6 W	6 W	4 W
Nutzlicht   Real lumen	430 Lm	480 Lm	530 Lm	530 Lm	360 Lm
Leuchte Energieeffizienzklasse Luminaire energy efficiency class					
Farbtemperatur   Color temperature	5000 K				
Farbwiedergabe   Color rendering	> 80				
Lebensdauer LED   Lifetime LED	> 50.000 h				
Umgebungstemp.   Ambient temp.	-20°C - +40°C				
IP Schutzart   IP protection class	IP54 (IP65 optional)				
Diffusor   Diffuser	ja   yes				
Schutzrohr   Protective tube	Polycarbonat				
Handgriff / Kappe   Handle / End cap	PVC				
Zuleitung   Cable	5m H05RN-F 2 x 1,00mm <sup>2</sup>				
Stecker   Plug	230V Version: ja   yes (110V / 42V / 24V / 12V optional)				

### ABMESSUNGEN | DIMENSIONS (IN MM)

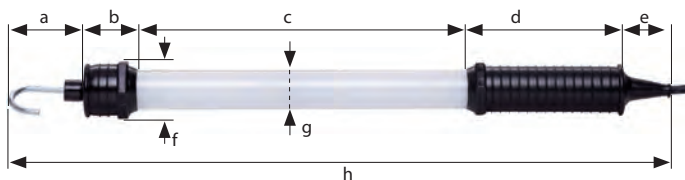

a	b	c	d	e	f	g	h
45	55	270	115	40	45	30	525

Gewicht | Weight: ca. 0,5kg

### ZUBEHÖR | ACCESSORIES



# KE-LED 3010-P IP68 | LED HANDLEUCHTE | LED HAND LAMP

## Merkmale | Features

10x  
POWER  
LED

24V

IP68

H07  
RN-F  
BQ-F

III

Qualität  
MADE IN GERMANY

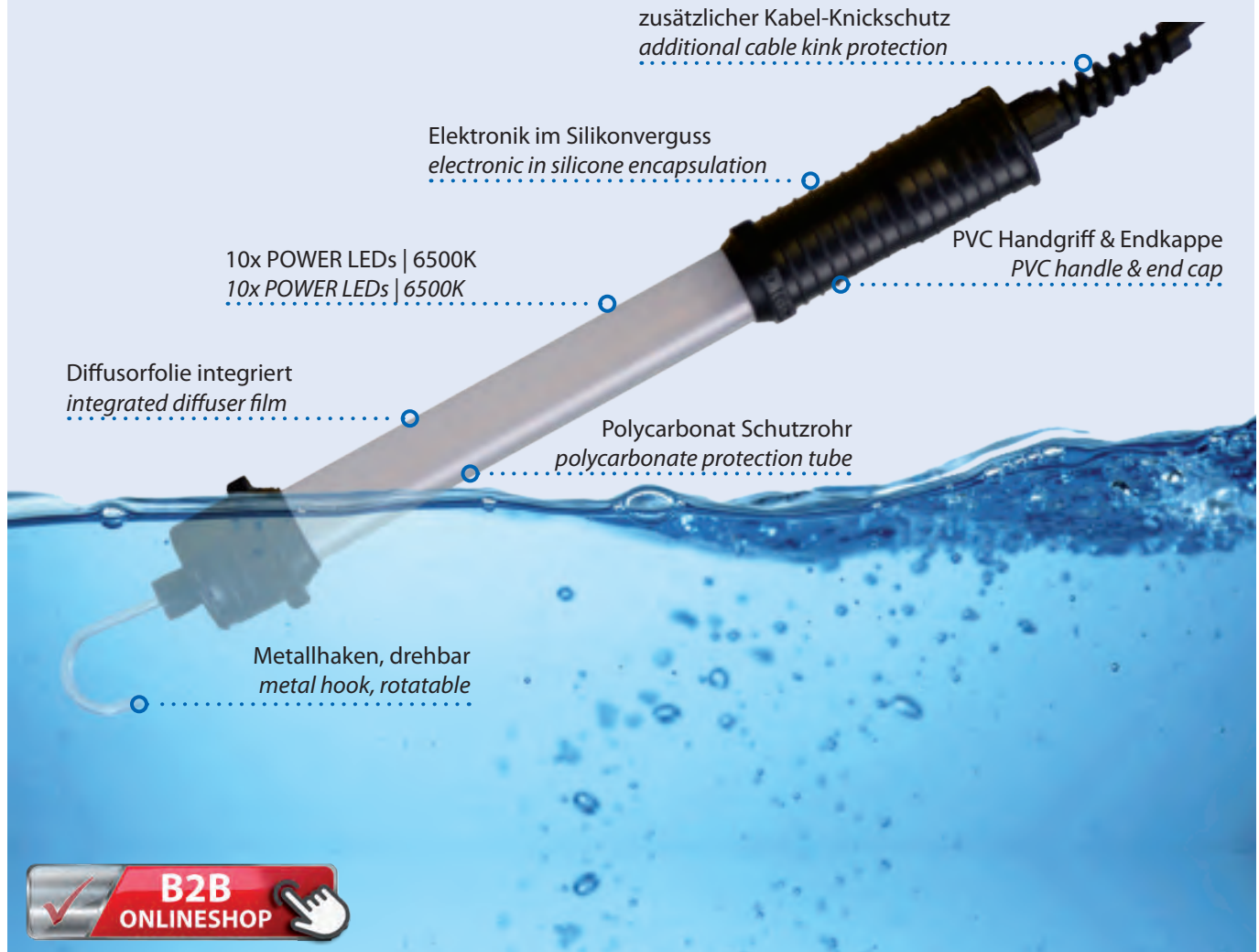

zusätzlicher Kabel-Knickschutz  
*additional cable kink protection*

Elektronik im Silikonverguss  
*electronic in silicone encapsulation*

10x POWER LEDs | 6500K  
*10x POWER LEDs | 6500K*

PVC Handgriff & Endkappe  
*PVC handle & end cap*

Diffusorfolie integriert  
*integrated diffuser film*

Polycarbonat Schutzrohr  
*polycarbonate protection tube*

Metallhaken, drehbar  
*metal hook, rotatable*



## VORTEILE | ADVANTAGES

- Staub- und wasserdicht, ideal für Arbeiten in feuchter und nasser Arbeitsumgebung
- zusätzlich angebrachter Kabelknickschutz
- lichtstark trotz kompakter Größe
- *dustproof and waterproof, ideal for working in damp and wet working environments*
- *additionally attached cable kink protection*
- *bright despite the compact size*

## EINSATZBEREICHE | AREAS OF APPLICATION

- Inspektions- & Servicearbeiten
- Tank- bzw. Fassreinigung
- Industriereinigung
- *inspection and service work*
- *tank or barrel cleaning*
- *industrial cleaning*



# KE-LED 3010-P IP68 | LED HANDLEUCHTE | LED HAND LAMP



**LED Handleuchte, staub- und wasserdicht, ideal für Arbeiten in feuchter und nasser Umgebung.**

- Leuchtmittel: 10 POWER LEDs / 6500K
- Schutzrohr: Polycarbonat, schlagfest, 30mm Ø
- Handgriff / Abschlusskappe: PVC, schwarz
- Metallhaken: ja, drehbar
- Schutzart: IP68
- Schutzklasse: III
- Zuleitung: 10m H07RN-F 2 x 1,00mm<sup>2</sup>
- Spannungsvariante: 24V
- Längere Zuleitung, Kabeltyp, Stecker auf Anfrage



**LED hand lamp, dustproof and waterproof, ideal for working in damp and wet environments.**

- Illuminant: 10 POWER LEDs / 6500K
- Protective tube: polycarbonate, 30mm Ø
- Handle / end cap: PVC, black
- Metal hook: yes, rotatable
- Protection category: IP68
- Protection class: III
- Cable: 10m H07RN-F 2 x 1,00mm<sup>2</sup>
- Voltage variant: 24V
- Longer cable, cable type, plug etc. on request

## TECHNISCHE DATEN | TECHNICAL DATA

Art.-Nr.   Art.-No.	131532
Nennspannung   Nominal voltage	24V AC/DC
Strom   Current	0,215 A
Schutzklasse   Protection class	III
Anzahl LED   Number LED	10
Leistung   Power	6 W
Nutzlicht   Real lumen	580 Lm
Leuchte Energieeffizienzklasse Luminaire energy efficiency class	
Farbtemperatur   Color temperature	6500 K
Farbwiedergabe   Color rendering	> 70
Lebensdauer LED   Lifetime LED	> 50.000 h
Umgebungstemp.   Ambient temp.	-20°C - +40°C
IP Schutzart   IP protection class	IP68
Diffusor   Diffuser	ja   yes
Schutzrohr   Protective tube	Polycarbonat
Handgriff / Kappe   Handle / End cap	PVC
Zuleitung   Cable	10m H07RN-F 2 x 1,00mm <sup>2</sup> (optional H07BQ-F)
Stecker   Plug	optional

## ABMESSUNGEN | DIMENSIONS (IN MM)

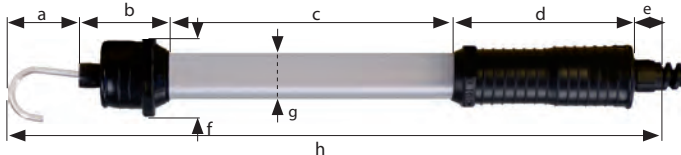

a	b	c	d	e	f	g	h
45	55	175	120	20	50	30	410
Gewicht   Weight: ca. 1,35kg							

## ZUBEHÖR | ACCESSORIES



# KE-LED 4010-P PROFI | LED HANDLEUCHE | LED HAND LAMP

## Merkmale | Features

10x  
POWER  
LED

230V  
110V  
42V  
24V

IP54

H05  
RN-F

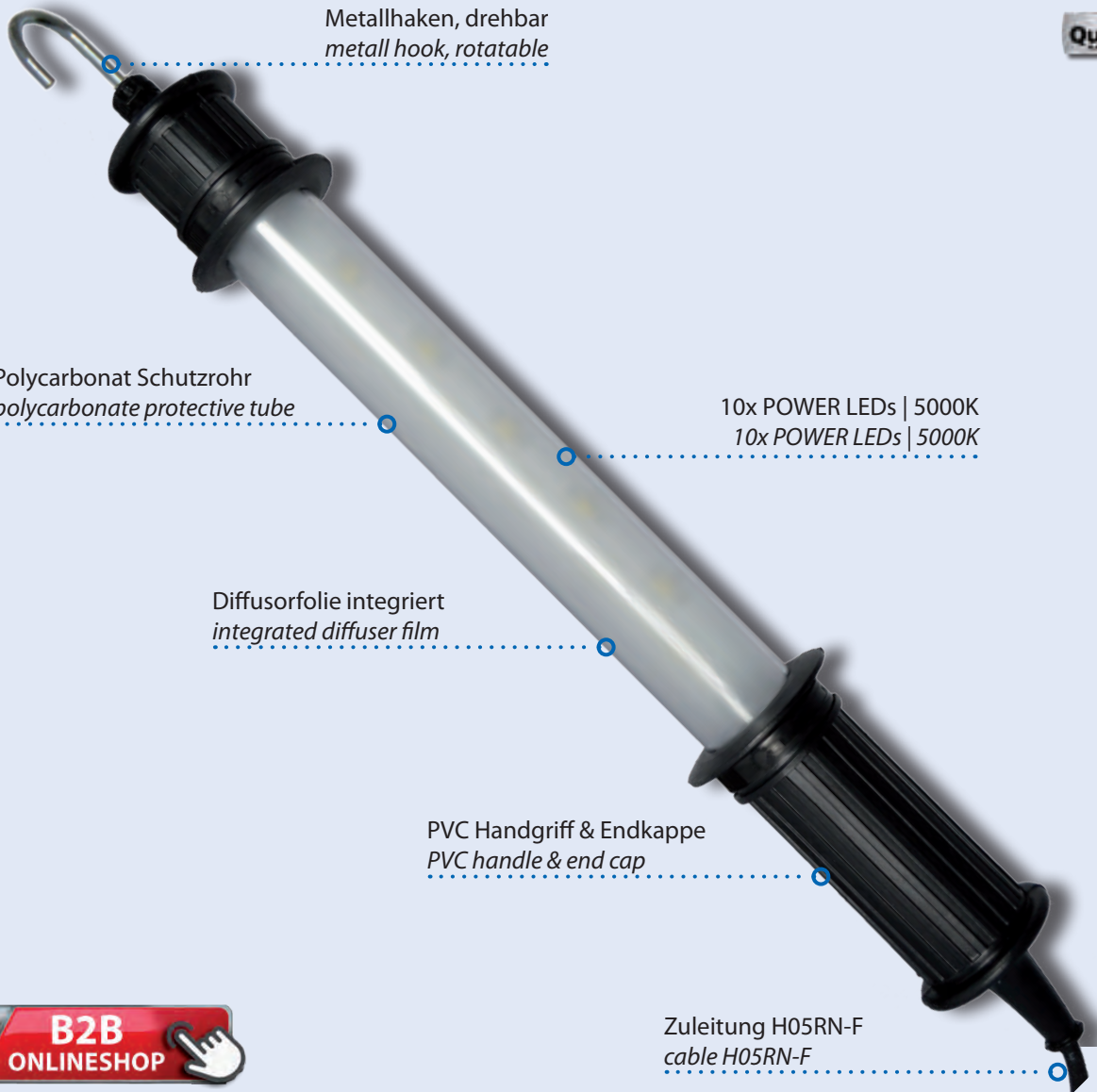

Metallhaken, drehbar  
*metall hook, rotatable*

Polycarbonat Schutzrohr  
*polycarbonate protective tube*

10x POWER LEDs | 5000K  
*10x POWER LEDs | 5000K*

Diffusorfolie integriert  
*integrated diffuser film*

PVC Handgriff & Endkappe  
*PVC handle & end cap*

Zuleitung H05RN-F  
*cablE H05RN-F*



## VORTEILE | ADVANTAGES

- hohe Lichtausbeute aufgrund 10x POWER LED
- blendfreies Arbeitslicht dank integrierter Diffusorfolie
- in verschiedenen Spannungsvarianten erhältlich
- *high luminous efficiency due to 10x POWER LED*
- *glare-free work light thanks to the integrated diffuser film*
- *available in different voltage versions*

## EINSATZBEREICHE | AREAS OF APPLICATION

- Inspektions- & Servicearbeiten
- KFZ-Werkstätten
- Industrie- und Handwerk
- *inspection and service work*
- *car workshops*
- *industry & crafts*

# KE-LED 4010-P PROFI | LED HANDLEUCHE | LED HAND LAMP



Die Profi-LED Handleuchte KE-LED 4010-P ist die bewährte Beleuchtungslösung im Werkstattbereich.

- Leuchtmittel: 10 POWER LEDs / 5000K
- Schutzrohr: Polycarbonat, schlagfest, 40mm Ø
- Handgriff / Abschlusskappe: PVC, schwarz
- Metallhaken: ja, drehbar
- Schutzart: IP54
- Schutzklasse: II bzw. III
- Zuleitung: 5m H05RN-F 2 x 1,00mm<sup>2</sup>
- Spannungsvarianten: 230V / 110V / 42V / 24V
- Längere Zuleitung, Kabeltyp, Stecker auf Anfrage



The professional LED hand lamp KE-LED 4010-P is the proven lighting solution in the workshop area.

- Illuminant: 10 POWER LEDs / 5000K
- Protective tube: polycarbonate, 40mm Ø
- Handle / end cap: PVC, black
- Metal hook: yes, rotatable
- Protection category: IP54
- Protection class: II resp. III
- Cable: 5m H05RN-F 2 x 1,00mm<sup>2</sup>
- Voltage variants: 230V / 110V / 42V / 24V
- Longer cable, cable type, plug etc. on request

## TECHNISCHE DATEN | TECHNICAL DATA

Art.-Nr.   Art.-No.	131364	131368	131369	131365
Nennspannung   Nominal voltage	220-240V AC	110V AC/DC	42V AC/DC	24V AC/DC
Strom   Current	0,04 A	0,085 A	0,165 A	0,32 A
Schutzklasse   Protection class	II	II	III	III
Anzahl LED   Number LED	10	10	10	10
Leistung   Power	6,7 W	6,5 W	8 W	8,5 W
Nutzlicht   Real lumen	670 Lm	700 Lm	800 Lm	820 Lm
Leuchte Energieeffizienzklasse Luminaire energy efficiency class				
Farbtemperatur   Color temperature	5000 K			
Farbwiedergabe   Color rendering	> 80			
Lebensdauer LED   Lifetime LED	> 50.000 h			
Umgebungstemp.   Ambient temp.	-20°C - +40°C			
IP Schutzart   IP protection class	IP54			
Diffusor   Diffuser	ja   yes			
Schutzrohr   Protective tube	Polycarbonat			
Handgriff / Kappe   Handle / End cap	PVC			
Zuleitung   Cable	5m H05RN-F 2 x 1,00mm <sup>2</sup>			
Stecker   Plug	230V Version: ja   yes (110V / 42V / 24V optional)			

## ABMESSUNGEN | DIMENSIONS (IN MM)

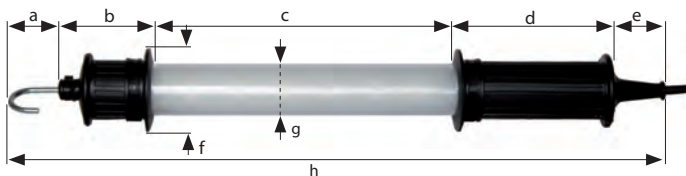

a	b	c	d	e	f	g	h
45	70	240	115	40	65	40	510

Gewicht | Weight: ca. 0,75kg

## ZUBEHÖR | ACCESSORIES



# KE-LED 4010-P INDUSTRIE | LED HANDLEUCHE | LED HAND LAMP

## Merkmale | Features

10x  
POWER  
LED

230V  
110V  
42V  
24V

IP65

H07  
RN-F



## VORTEILE | ADVANTAGES

- staubdicht & geschützt gegen Strahlwasser
- Neopren-Handgriff mit angenehmer Haptik
- hohe Lichtausbeute aufgrund 10x POWER LED
- in verschiedenen Spannungsvarianten erhältlich
- *dustproof & protected against water jets*
- *neoprene handle with a pleasant feel*
- *high luminous efficiency due to 10x POWER LED*
- *available in different voltage versions*

## EINSATZBEREICHE | AREAS OF APPLICATION

- KFZ-Werkstätten
- Industrie- und Handwerk
- Inspektions- & Servicearbeiten
- Tank- und Fassreinigung
- *car workshops*
- *industry & crafts*
- *inspection and service work*
- *tank and barrel cleaning*

# KE-LED 4010-P INDUSTRIE | LED HANDLEUCHE | LED HAND LAMP



**KE-LED 4010-P, die bewährte LED Handleuchte als Industrie-Ausführung, mit erhöhter IP-Schutzart.**

- Leuchtmittel: 10 POWER LEDs / 5000K
- Schutzrohr: Polycarbonat, schlagfest, 40mm Ø
- Handgriff / Abschlusskappe: Neopren, schwarz
- Metallhaken: ja, drehbar
- Schutzart: IP65
- Schutzklasse: II bzw. III
- Zuleitung: 5m H07RN-F 2 x 1,00mm<sup>2</sup>
- Spannungsvarianten: 230V / 110V / 42V / 24V
- Längere Zuleitung, Kabeltyp, Stecker auf Anfrage



**KE-LED 4010-P, the proven LED hand lamp as an industrial version, with increased IP protection class.**

- Illuminant: 10 POWER LEDs / 5000K
- Protective tube: polycarbonate, 40mm Ø
- Handle / end cap: neoprene, black
- Metal hook: yes, rotatable
- Protection category: IP68
- Protection class: II resp. III
- Cable: 5m H07RN-F 2 x 1,00mm<sup>2</sup>
- Voltage variants: 230V / 110V / 42V / 24V
- Longer cable, cable type, plug etc. on request

## TECHNISCHE DATEN | TECHNICAL DATA

Art.-Nr.   Art.-No.	131429	131430	131431	131432
Nennspannung   Nominal voltage	220-240V AC	110V AC/DC	42V AC/DC	24V AC/DC
Strom   Current	0,04 A	0,085 A	0,165 A	0,32 A
Schutzklasse   Protection class	II	II	III	III
Anzahl LED   Number LED	10	10	10	10
Leistung   Power	6,7 W	6,5 W	8 W	8,5 W
Nutzlicht   Real lumen	670 Lm	700 Lm	800 Lm	820 Lm
Leuchte Energieeffizienzklasse Luminaire energy efficiency class				
Farbtemperatur   Color temperature	5000 K			
Farbwiedergabe   Color rendering	> 80			
Lebensdauer LED   Lifetime LED	> 50.000 h			
Umgebungstemp.   Ambient temp.	-20°C - +40°C			
IP Schutzart   IP protection class	IP65			
Diffusor   Diffuser	ja   yes			
Schutzrohr   Protective tube	Polycarbonat			
Handgriff / Kappe   Handle / End cap	Neopren			
Zuleitung   Cable	5m H07RN-F 2 x 1,00mm <sup>2</sup>			
Stecker   Plug	230V Version: ja   yes (110V / 42V / 24V optional)			

## ABMESSUNGEN | DIMENSIONS (IN MM)

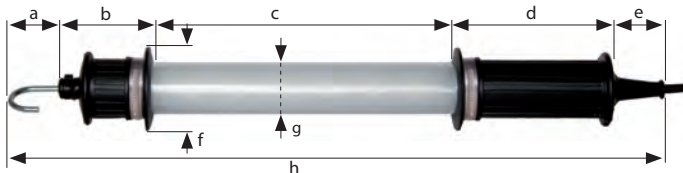

a	b	c	d	e	f	g	h
45	70	240	115	40	65	40	510
Gewicht   Weight: ca. 0,75kg							

## ZUBEHÖR | ACCESSORIES



# KE-LED 5024-P IP68 | LED HANDLEUCHE | LED HAND LAMP

## Merkmale | Features

24x  
POWER  
LED

24V

IP68

H07  
RN-F  
BQ-F

III

Qualität  
MADE IN GERMANY



## VORTEILE | ADVANTAGES

- staub- und wasserdicht, ideal für Arbeiten in feuchter und nasser Arbeitsumgebung
- zusätzlich angebrachter Kabelknickschutz
- hohe Lichtleistung dank 24x POWER LED
- *dustproof and waterproof, ideal for working in damp and wet working environments*
- *additionally attached cable kink protection*
- *high light output due to 24x POWER LED*

## EINSATZBEREICHE | AREAS OF APPLICATION

- Inspektions- & Servicearbeiten
- Tank- bzw. Fassreinigung
- Industriereinigung
- *inspection and service work*
- *tank or barrel cleaning*
- *industrial cleaning*





# KE-LED 5024-P IP68 | LED HANDLEUCHTE | LED HAND LAMP



**Extrem lichtstarke LED Handleuchte mit IP68 Schutz, für den Einsatz in feuchter und nasser Arbeitsumgebung.**

- Leuchtmittel: 24 POWER LEDs / 6500K
- Schutzrohr: Polycarbonat, schlagfest, 50mm Ø
- Handgriff / Abschlusskappe: Neopren, schwarz
- Metallhaken: ja, drehbar
- Schutzart: IP68
- Schutzklasse: III
- Zuleitung: 10m H05RN-F 2 x 1,00mm<sup>2</sup>
- Spannungsvariante: 24V
- Längere Zuleitung, Kabeltyp, Stecker auf Anfrage



**Extremely bright LED hand lamp with IP68 protection, for use in damp and wet working environments.**

- Illuminant: 24 POWER LEDs / 6500K
- Protective tube: polycarbonate, 50mm Ø
- Handle / end cap: neoprene, black
- Metal hook: yes, rotatable
- Protection category: IP68
- Protection class: III
- Cable: 10m H05RN-F 2 x 1,00mm<sup>2</sup>
- Voltage variant: 24V
- Longer cable, cable type, plug etc. on request

## TECHNISCHE DATEN | TECHNICAL DATA

<b>Art.-Nr.   Art.-No.</b>	<b>131521</b>
Nennspannung   Nominal voltage	24V AC/DC
Strom   Current	0,550 A
Schutzklasse   Protection class	III
Anzahl LED   Number LED	24
Leistung   Power	15,5 W
Nutzlicht   Real lumen	1650 Lm
Leuchte Energieeffizienzklasse Luminaire energy efficiency class	
Farbtemperatur   Color temperature	6500 K
Farbwiedergabe   Color rendering	> 70
Lebensdauer LED   Lifetime LED	> 50.000 h
Umgebungstemp.   Ambient temp.	-20°C - +40°C
IP Schutzart   IP protection class	IP68
Diffusor   Diffuser	ja   yes
Schutzrohr   Protective tube	Polycarbonat
Handgriff / Kappe   Handle / End cap	Neopren
Zuleitung   Cable	10m H07RN-F 2 x 1,00mm <sup>2</sup> (optional H07BQ-F)
Stecker   Plug	optional

## ABMESSUNGEN | DIMENSIONS (IN MM)



a	b	c	d	e	f	g	h	i	j
30	50	30	480	90	130	20	75	50	830
Gewicht   Weight: ca. 2,2kg									

## ZUBEHÖR | ACCESSORIES



# KE-LED 5030-P | LED HANDLEUCHE | LED HAND LAMP

## Merkmale | Features

30x  
POWER  
LED

230V  
110V  
42V  
24V

IP65

H07  
RN-F



Metallhaken, drehbar  
*metall hook, rotatable*

Polycarbonat Schutzrohr  
*polycarbonate protective tube*

30x POWER LEDs | 5000K  
*30x POWER LEDs | 5000K*

Diffusorfolie integriert  
*integrated diffuser film*

Neopren Handgriff & Endkappe  
*neoprene handle & end cap*

Zuleitung H07RN-F  
*cabl e H07RN-F*



## VORTEILE | ADVANTAGES

- Neopren-Handgriff mit angenehmer Haptik
- hohe Lichtausbeute dank 30x POWER LED
- in verschiedenen Spannungsvarianten erhältlich
- *neoprene handle with a pleasant feel*
- *high luminous efficiency due to 10x POWER LED*
- *available in different voltage versions*

## EINSATZBEREICHE | AREAS OF APPLICATION

- KFZ-Werkstätten
- Industrie- und Handwerk
- Inspektions- & Servicearbeiten
- *car workshops*
- *industry & crafts*
- *inspection and service work*

# KE-LED 5030-P | LED HANDLEUCHE | LED HAND LAMP



Die XXL LED Handleuchte KE-LED 5030-P zeichnet sich durch ihre hohe Lichtleistung aus.

- Leuchtmittel: 30 POWER LEDs / 5000K
- Schutzrohr: Polycarbonat, schlagfest, 50mm Ø
- Handgriff / Abschlusskappe: Neopren, schwarz
- Metallhaken: ja, drehbar
- Schutzart: IP65
- Schutzklasse: II bzw. III
- Zuleitung: 5m H07RN-F 2 x 1,00mm<sup>2</sup>
- Spannungsvarianten: 230V / 110V / 42V / 24V
- Längere Zuleitung, Kabeltyp, Stecker auf Anfrage



The XXL LED hand lamp KE-LED 5030-P is characterized by its high light output.

- Illuminant: 30 POWER LEDs / 5000K
- Protective tube: polycarbonate, 50mm Ø
- Handle / end cap: neoprene, black
- Metal hook: yes, rotatable
- Protection category: IP68
- Protection class: II resp. III
- Cable: 5m H07RN-F 2 x 1,00mm<sup>2</sup>
- Voltage variants: 230V / 110V / 42V / 24V
- Longer cable, cable type, plug etc. on request

## TECHNISCHE DATEN | TECHNICAL DATA

Art.-Nr.   Art.-No.	131480	131481	131482	131483
Nennspannung   Nominal voltage	220-240V AC	110V AC/DC	42V AC/DC	24V AC/DC
Strom   Current	0,125 A	0,185 A	0,390 A	0,7 A
Schutzklasse   Protection class	II	II	III	III
Anzahl LED   Number LED	30	30	30	30
Leistung   Power	25 W	20 W	20 W	21 W
Nutzlicht   Real lumen	2800 Lm	2380 Lm	2250 Lm	2300 Lm
Leuchte Energieeffizienzklasse Luminaire energy efficiency class				
Farbtemperatur   Color temperature	5000 K			
Farbwiedergabe   Color rendering	> 80			
Lebensdauer LED   Lifetime LED	> 50.000 h			
Umgebungstemp.   Ambient temp.	-20°C - +40°C			
IP Schutzart   IP protection class	IP65			
Diffusor   Diffuser	ja   yes			
Schutzrohr   Protective tube	Polycarbonat			
Handgriff / Kappe   Handle / End cap	Neopren			
Zuleitung   Cable	5m H07RN-F 2 x 1,00mm <sup>2</sup>			
Stecker   Plug	230V Version: ja   yes (110V / 42V / 24V optional)			

## ABMESSUNGEN | DIMENSIONS (IN MM)

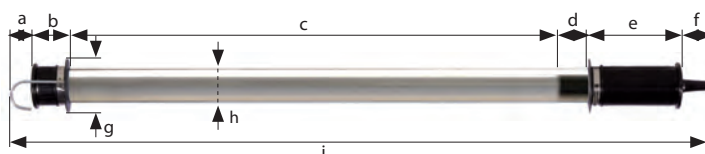

a	b	c	d	e	f	g	h	i
30	50	640	50	130	40	75	50	945

Gewicht | Weight: ca. 1,5kg

## ZUBEHÖR | ACCESSORIES



# TRANSFORMATOREN | TRANSFORMERS

## TRANSFORMATOREN FÜR SCHUTZKLEINSPANNUNG | TRANSFORMERS FOR SAFETY EXTRA-LOW VOLTAGE

Art.-Nr.

### Typ 230V - 12V

SELV 25/1-12 | 230V-12V | 25VA | 1x12V Steckdose/Vergussgehäuse | 1x12V socket/plastic housing 141130

### Typ 230V - 24V

SELV 25/1-24 | 230V-24V | 25VA | 1x24V CEE-Steckdose/Vergussgehäuse | 1x24V CEE socket/plastic housing 141133

SELV 60/1-24 | 230V-24V | 60VA | 1x24V CEE-Steckdose/Gummigehäuse | 1x24V CEE socket/rubber housing 141124

SELV 100/1-24 | 230V-24V | 100VA | 1x24V CEE-Steckdose/Gummigehäuse | 1x24V CEE socket/rubber housing 141100

SELV 160/2-24 | 230V-24V | 160VA | 2x24V CEE-Steckdose/Gummigehäuse | 2x24V CEE socket/rubber housing 141160

SELV 250/2-24 | 230V-24V | 250VA | 2x24V CEE-Steckdose/Gummigehäuse | 2x24V CEE socket/rubber housing 141170

SELV 250/4-24 | 230V-24V | 250VA | 4x24V CEE-Steckdose/Gummigehäuse | 4x24V CEE socket/rubber housing 141128

### Typ 230V - 42V

SELV 25/1-42 | 230V-42V | 25VA | 1x42V CEE-Steckdose/Vergussgehäuse | 1x42V CEE socket/plastic housing 141135

SELV 60/1-42 | 230V-42V | 60VA | 1x42V CEE-Steckdose/Gummigehäuse | 1x42V CEE socket/rubber housing 141142

SELV 100/1-42 | 230V-42V | 100VA | 1x42V CEE-Steckdose/Gummigehäuse | 1x42V CEE socket/rubber housing 141200

SELV 160/2-42 | 230V-42V | 160VA | 2x42V CEE-Steckdose/Gummigehäuse | 2x42V CEE socket/rubber housing 141210

SELV 250/2-42 | 230V-42V | 250VA | 2x42V CEE-Steckdose/Gummigehäuse | 2x42V CEE socket/rubber housing 141211



Vollvergussgehäuse  
encapsulation housing



Vollvergussgehäuse  
encapsulation housing



Vollgummigehäuse KV10  
solid rubber housing KV10



Vollgummigehäuse KV11  
solid rubber housing KV11



# KIRA LED Rohrleuchten - Einsatzgebiete

## KIRA LED tube luminaires - areas of application



**Druckindustrie**  
*printing industry*



**Klima- und Ablufttechnik**  
*air conditioning*



**Anlagenbau**  
*plant construction*



**Maschinenbau**  
*mechanical engineering*



**Hebebühnen**  
*hydraulic ramps*



**Tunnelanlagen**  
*tunnel systems*



**Katastrophenschutz**  
*civil protection*



# KE-LED-EA 3003-K | LED ROHRLEUCHE | LED TUBE LUMINAIRE

## Merkmale | Features

3x  
POWER  
LED

24V

IP54

H05  
RN-F

III

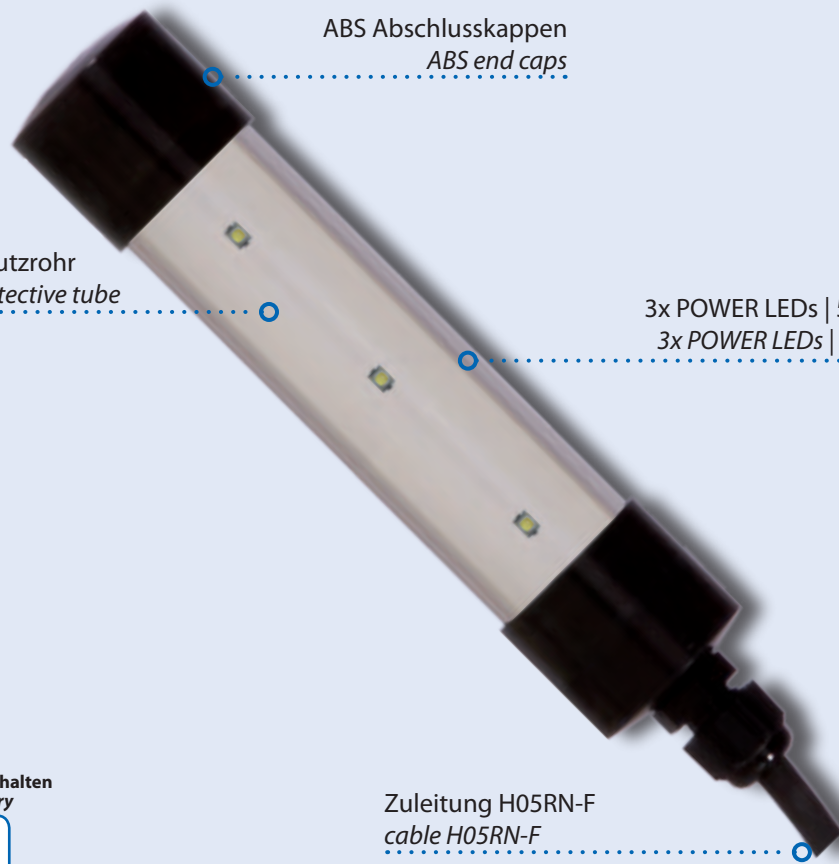

ABS Abschlusskappen  
ABS end caps

Plexiglas Schutzrohr  
plexiglass protective tube

3x POWER LEDs | 5000K  
3x POWER LEDs | 5000K

Zuleitung H05RN-F  
cable H05RN-F

im Lieferumfang enthalten  
in the scope of delivery



2x Federstahlklammer  
2x spring steel clamp

## VORTEILE | ADVANTAGES

- kompakte Abmessungen & geringes Gewicht
- ideal bei engen Platzverhältnissen
- compact dimensions & low weight
- ideal for tight spaces

## EINSATZBEREICHE | AREAS OF APPLICATION

- Maschinenbau
- Schaltanlagenbau
- Fahrzeugbau
- mechanical engineering
- switchgear manufacturing
- vehicle construction

# KE-LED-EA 3003-K | LED ROHRLEUCHE | LED TUBE LUMINAIRE



**Kompakte LED-Rohrleuchte. Ideal für den Einbau in Maschinen, Fahrzeugen und Anlagen mit begrenzten Montagemöglichkeiten.**

- Leuchtmittel: 3 POWER LEDs / 5000K
- Schutzrohr: Plexiglas, 30mm Ø
- Abschlusskappen: ABS, schwarz
- Befestigung: 2x Federstahlklammer
- Schutzart: IP54
- Schutzklasse: III
- Zuleitung: 5m H05RN-F 2 x 1,00mm<sup>2</sup>
- Spannungsvariante: 24V
- Längere Zuleitung, Kabeltyp, Stecker auf Anfrage



**Compact LED tube luminaire. Ideal for installation in machines, vehicles and systems with limited mounting options.**

- Illuminant: 3 POWER LEDs / 5000K
- Protective tube: plexiglass, 30mm Ø
- End caps: ABS, black
- Fixation: 2x metal clip
- Protection category: IP54
- Protection class: III
- Cable: 5m H05RN-F 2 x 1,00mm<sup>2</sup>
- Voltage variant: 24V
- Longer cable, cable type, plug etc. on request

## TECHNISCHE DATEN | TECHNICAL DATA

Art.-Nr.   Art.-No.	131620
Nennspannung   Nominal voltage	24V DC
Strom   Current	0,15 A
Schutzklasse   Protection class	III
Anzahl LED   Number LED	3
Leistung   Power	3,5 W
Nutzlicht   Real lumen	250 Lm
Leuchte Energieeffizienzklasse Luminaire energy efficiency class	
Farbtemperatur   Color temperature	5000 K
Farbwiedergabe   Color rendering	> 80
Lebensdauer LED   Lifetime LED	> 50.000 h
Umgebungstemp.   Ambient temp.	-20°C - +40°C
IP Schutzart   IP protection class	IP54
Diffusor   Diffuser	nein   no
Schutzrohr   Protective tube	Plexiglas   plexiglass
Abschlusskappen   End caps	ABS, Kunststoff   ABS plastic
Zuleitung   Cable	5m H05RN-F 2 x 1,00mm <sup>2</sup>
Stecker   Plug	optional

## ABMESSUNGEN | DIMENSIONS (IN MM)

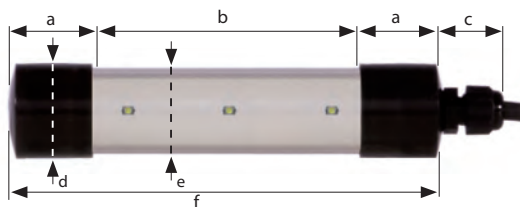

a	b	c	d	e	g
25	94	20	33	30	150

Gewicht | Weight: ca. 0,4kg

## ZUBEHÖR | ACCESSORIES



# KE-LED-EA 3003-L | LED ROHRLEUCHE | LED TUBE LUMINAIRE

## Merkmale | Features

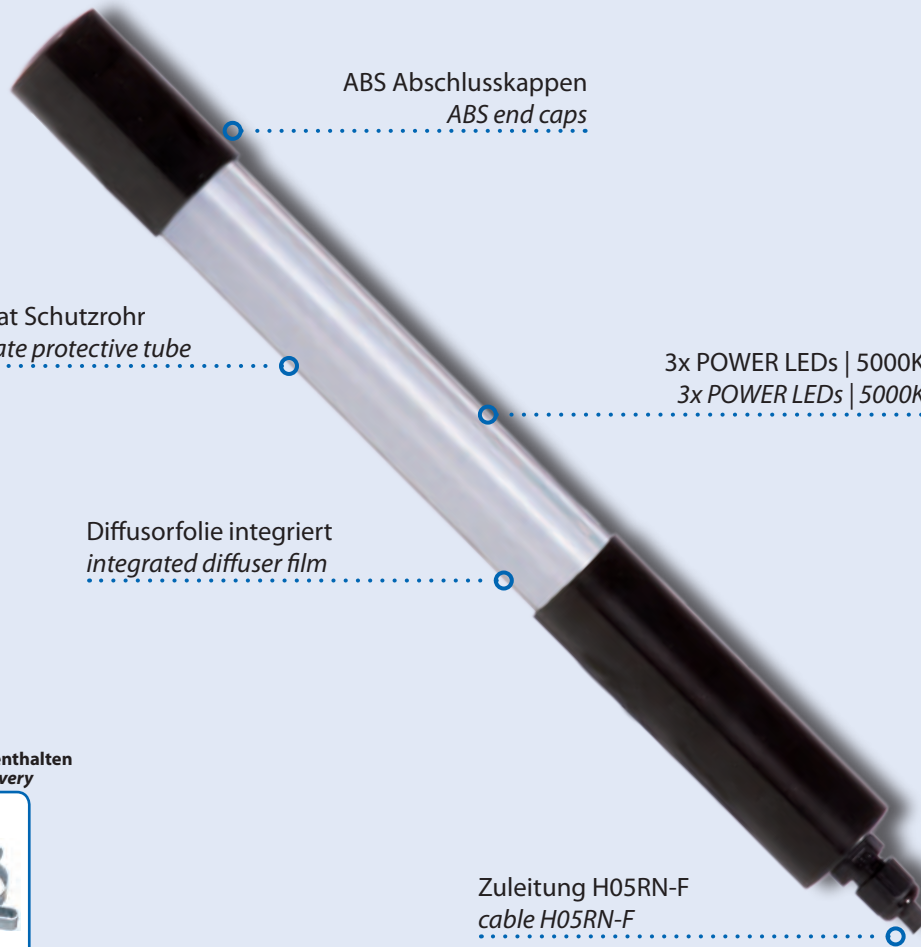

ABS Abschlusskappen  
*ABS end caps*

Polycarbonat Schutzrohr  
*polycarbonate protective tube*

3x POWER LEDs | 5000K  
3x POWER LEDs | 5000K

Diffusorfolie integriert  
*integrated diffuser film*

im Lieferumfang enthalten  
*in the scope of delivery*



2x Federstahlklammer  
*2x spring steel clamp*

Zuleitung H05RN-F  
*cable H05RN-F*



## VORTEILE | ADVANTAGES

- schlanke Bauform, ideal bei engen Einbauverhältnissen
- schlagfestes Polycarbonatschutzrohr
- in verschiedenen Spannungsvarianten erhältlich
- *slim design, ideal for tight installation conditions*
- *impact-resistant polycarbonate protective tube*
- *available in different voltage versions*

## EINSATZBEREICHE | AREAS OF APPLICATION

- Maschinenbau
- Schaltanlagenbau
- Fahrzeugbau
- *mechanical engineering*
- *switchgear manufacturing*
- *air conditioning and exhaust air systems*

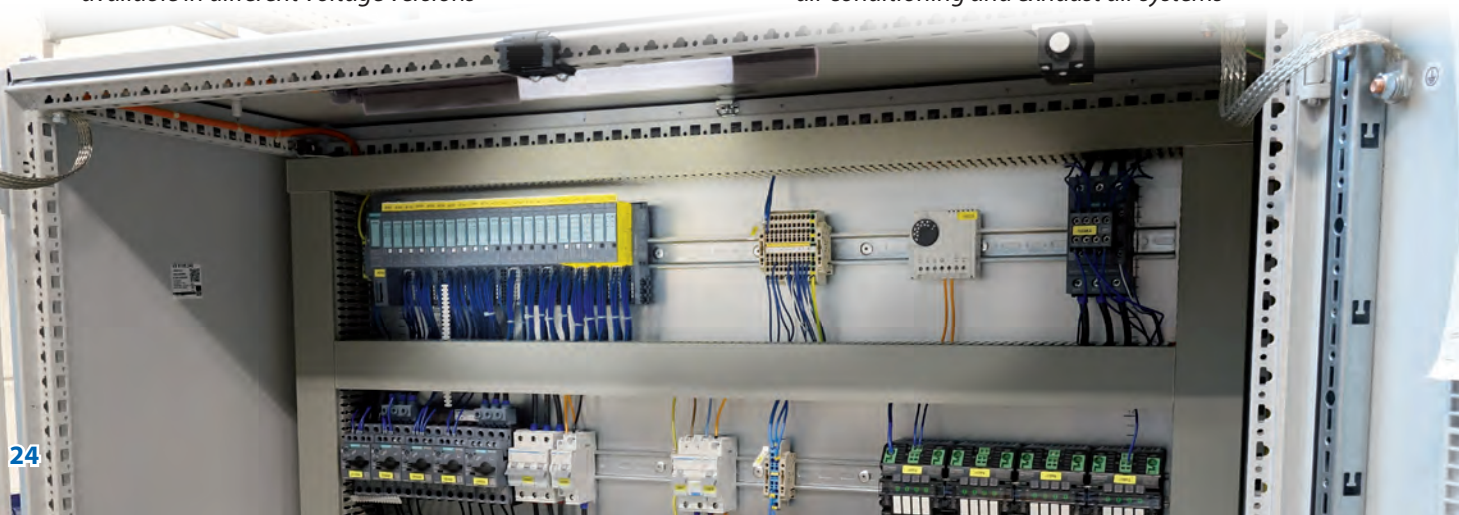



# KE-LED-EA 3003-L | LED ROHRLEUCHE | LED TUBE LUMINAIRE



**LED Rohrleuchte, ideal für den Einbau in Maschinen, Fahrzeugen und elektrischen Geräten aller Art. Blendfreies Licht dank speziellem Prismenschutzrohr.**

- Leuchtmittel: 3 POWER LEDs / 5000K
- Schutzrohr: Polycarbonat, 30mm Ø
- Abschlusskappen: ABS, schwarz
- Befestigung: 2x Federstahlklammer
- Schutzart: IP54
- Schutzklasse: II bzw. III
- Zuleitung: 5m H05RN-F 2 x 1,00mm<sup>2</sup>
- Spannungsvarianten: 230V / 110V / 24V
- Längere Zuleitung, Kabeltyp, Stecker auf Anfrage



**LED tube luminaire, ideal for the integration in machines, vehicles and electric devices. Dazzle-free light based on prismatic-shaped protection tub.**

- Illuminant: 3 POWER LEDs / 5000K
- Protective tube: polycarbonate, 30mm Ø
- End caps: ABS, black
- Fixation: 2x metal bracket
- Protection category: IP54
- Protection class: II resp. III
- Cable: 5m H05RN-F 2 x 1,00mm<sup>2</sup>
- Voltage variants: 230V / 110V / 24V
- Longer cable, cable type, plug etc. on request

## TECHNISCHE DATEN | TECHNICAL DATA

Art.-Nr.   Art.-No.	131625	131626	131628
Nennspannung   Nominal voltage	220-240V AC	110V AC/DC	24V AC/DC (12-24V)
Strom   Current	0,03 A	0,035 A	0,12 A
Schutzklasse   Protection class	II	II	III
Anzahl LED   Number LED	3	3	3
Leistung   Power	3,5 W	3,5 W	3,5 W
Nutzlicht   Real lumen	250 Lm	240 Lm	250 Lm
Leuchte Energieeffizienzklasse Luminaire energy efficiency class			
Farbtemperatur   Color temperature	5000 K		
Farbwiedergabe   Color rendering	> 80		
Lebensdauer LED   Lifetime LED	> 50.000 h		
Umgebungstemp.   Ambient temp.	-20°C - +40°C		
IP Schutzart   IP protection class	IP54		
Diffusor   Diffuser	ja   yes		
Schutzrohr   Protective tube	Polycarbonat		
Abschlusskappen   End caps	ABS		
Zuleitung   Cable	5m H05RN-F 2 x 1,00mm <sup>2</sup>		
Stecker   Plug	230V Version: ja   yes (110V / 24V optional)		

## ABMESSUNGEN | DIMENSIONS (IN MM)

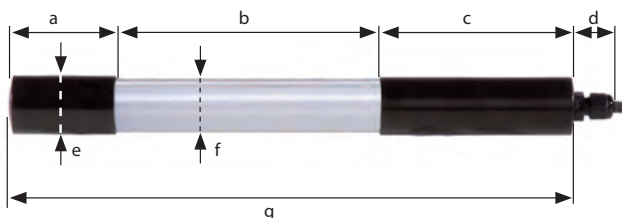

a	b	c	d	e	f	g
60	155	105	20	33	30	320

Gewicht | Weight: ca. 0,5kg

## ZUBEHÖR | ACCESSORIES



# KE-LED-EA 3006-P | LED ROHRLEUCHE | LED TUBE LUMINAIRE

## Merkmale | Features

6x  
POWER  
LED

230V  
110V  
42V  
24V  
12V

IP54

H05  
RN-F



ABS Abschlusskappen  
*ABS end caps*

Polycarbonat Schutzrohr  
*polycarbonate protective tube*

6x POWER LEDs | 5000K  
*6x POWER LEDs | 5000K*

Diffusorfolie integriert  
*integrated diffuser film*

im Lieferumfang enthalten  
*in the scope of delivery*



2x Federstahlklammer  
*2x spring steel clamp*

Zuleitung H05RN-F  
*cable H05RN-F*



## VORTEILE | ADVANTAGES

- schlanke Bauform, ideal bei engen Einbauverhältnissen
- schlagfestes Polycarbonatschutzrohr
- in verschiedenen Spannungsvarianten erhältlich
- *slim design, ideal for tight installation conditions*
- *impact-resistant polycarbonate protective tube*
- *available in different voltage versions*

## EINSATZBEREICHE | AREAS OF APPLICATION

- Maschinenbau
- Schaltanlagenbau
- Druckmaschinen
- *mechanical engineering*
- *switchgear manufacturing*
- *printing machines*

# KE-LED-EA 3006-P | LED ROHRLEUCHE | LED TUBE LUMINAIRE



**LED Rohrleuchte, ideal für den Einbau in Maschinen, Fahrzeugen und elektrischen Geräten aller Art. Blendfreies Licht dank speziellem Prismenschutzrohr.**

- Leuchtmittel: 6 POWER LEDs / 5000K
- Schutzrohr: Polycarbonat, 30mm Ø
- Abschlusskappen: ABS, schwarz
- Befestigung: 2x Federstahlklammer
- Schutzart: IP54
- Schutzklasse: II bzw. III
- Zuleitung: 5m H05RN-F 2 x 1,00mm<sup>2</sup>
- Spannungsvarianten: 230V / 110V / 42V / 24V / 12V
- Längere Zuleitung, Kabeltyp, Stecker auf Anfrage



**LED tube luminaire, ideal for the integration in machines, vehicles and electric devices. Dazzle-free light based on prismatic-shaped protection tub.**

- Illuminant: 6 POWER LEDs / 5000K
- Protective tube: polycarbonate, 30mm Ø
- End caps: ABS, black
- Fixation: 2x metal bracket
- Protection category: IP54
- Protection class: II resp. III
- Cable: 5m H05RN-F 2 x 1,00mm<sup>2</sup>
- Voltage variants: 230V / 110V / 42V / 24V / 12V
- Longer cable, cable type, plug etc. on request

## TECHNISCHE DATEN | TECHNICAL DATA

Art.-Nr.   Art.-No.	131606	131607	131608	131609	131611
Nennspannung   Nominal voltage	220-240V AC	110V AC/DC	42V AC/DC	24V AC/DC	12V AC/DC
Strom   Current	0,035 A	0,06 A	0,12 A	0,21 A	0,275 A
Schutzklasse   Protection class	II	II	III	III	III
Anzahl LED   Number LED	6	6	6	6	6
Leistung   Power	5 W	5,7 W	6 W	6 W	4 W
Nutzlicht   Real lumen	430 Lm	480 Lm	530 Lm	530 Lm	360 Lm
Leuchte Energieeffizienzklasse Luminaire energy efficiency class					
Farbtemperatur   Color temperature	5000 K				
Farbwiedergabe   Color rendering	> 80				
Lebensdauer LED   Lifetime LED	> 50.000 h				
Umgebungstemp.   Ambient temp.	-20°C - +40°C				
IP Schutzart   IP protection class	IP54				
Diffusor   Diffuser	ja   yes				
Schutzrohr   Protective tube	Polycarbonat				
Abschlusskappen   End caps	ABS				
Zuleitung   Cable	5m H05RN-F 2 x 1,00mm <sup>2</sup>				
Stecker   Plug	230V Version: ja   yes (110V / 42V / 24V / 12V optional)				

## ABMESSUNGEN | DIMENSIONS (IN MM)

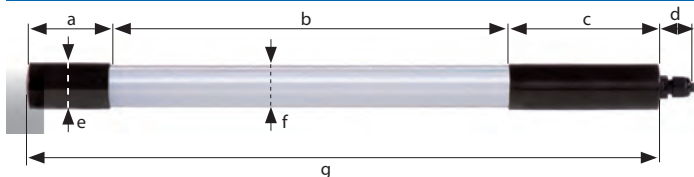

a	b	c	d	e	f	g
60	285	105	20	33	30	450

Gewicht | Weight: ca. 0,5kg

## ZUBEHÖR | ACCESSORIES



# KE-LED-EA 30.-P MODULAR | LED ROHRLEUCHTE | LED TUBE LUMINAIRE

## Merkmale | Features

6-30  
POWER  
LED

24V

IP54

H05  
RN-F

III

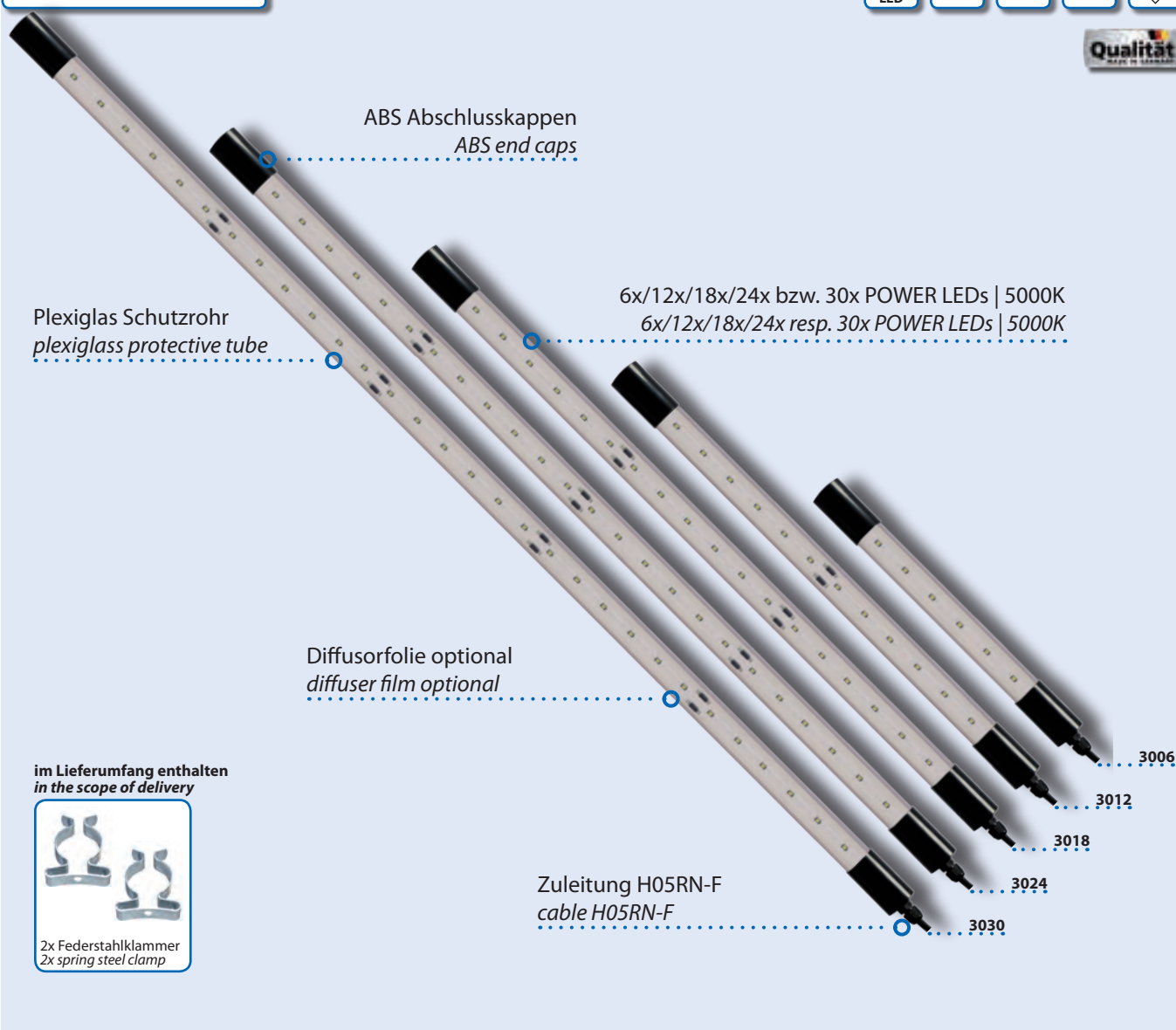

## VORTEILE | ADVANTAGES

- schlanke Bauform, ideal bei engen Einbauverhältnissen
- verschiedene Längen in gleichem Design
- ohne externes Vorschaltgerät einsetzbar
- *slim design, ideal for tight installation conditions*
- *different lengths in the same design*
- *can be used without an external ballast*

## EINSATZBEREICHE | AREAS OF APPLICATION

- Maschinenbau
- Schaltanlagenbau
- Schaltschränke
- *mechanical engineering*
- *switchgear manufacturing*
- *switch cabinet*

# KE-LED-EA 30.-P MODULAR | LED ROHRLEUCHTE | LED TUBE LUMINAIRE



**LED Rohrleuchte mit bis zu 30 POWER LEDs. Aufgrund der modularen Bauweise in verschiedenen Längen erhältlich.**

- Leuchtmittel: 6/12/18/24 bzw. 30 POWER LEDs / 5000 K
- Schutzrohr: Plexiglas, 30mm Ø
- Abschlusskappen: ABS, schwarz
- Befestigung: 2x Federstahlklammer
- Schutzart: IP54
- Schutzklasse: III
- Zuleitung: 5m H05RN-F 2 x 1,00mm<sup>2</sup>
- Spannungsvariante: 24V
- Längere Zuleitung, Kabeltyp, Stecker auf Anfrage



**LED tube luminaire with up to 30 POWER LED. Due to the modular construction available in different length.**

- Illuminant: 6/12/18/24 resp. 30 POWER LEDs / 5000 K
- Protective tube: plexiglass, 30mm Ø
- End caps: ABS, black
- Fixation: 2x metal bracket
- Protection category: IP54
- Protection class: III
- Cable: 5m H05RN-F 2 x 1,00mm<sup>2</sup>
- Voltage variant: 24V
- Longer cable, cable type, plug etc. on request

## TECHNISCHE DATEN | TECHNICAL DATA

Art.-Nr.   Art.-No.	131420	131421	131422	131423	131424
Nennspannung   Nominal voltage	24V AC/DC	24V AC/DC	24V AC/DC	24V AC/DC	24V AC/DC
Strom   Current	0,19 A	0,35 A	0,62 A	0,75 A	0,75 A
Schutzklasse   Protection class	III	III	III	III	III
Anzahl LED   Number LED	6	12	18	24	30
Leistung   Power	5,5 W	10 W	15 W	20,5 W	20,5 W
Nutzlicht   Real lumen	560 Lm	1050 Lm	1760 Lm	2250 Lm	2250 Lm
Leuchte Energieeffizienzklasse Luminaire energy efficiency class					
Farbtemperatur   Color temperature	5000 K				
Farbwiedergabe   Color rendering	> 80				
Lebensdauer LED   Lifetime LED	> 50.000 h				
Umgebungstemp.   Ambient temp.	-20°C - +40°C				
IP Schutzart   IP protection class	IP54				
Diffusor   Diffuser	optional				
Schutzrohr   Protective tube	Plexiglas				
Abschlusskappen   End caps	ABS				
Zuleitung   Cable	5m H05RN-F 2 x 1,00mm <sup>2</sup>				
Stecker   Plug	optional				

## ABMESSUNGEN | DIMENSIONS (IN MM)

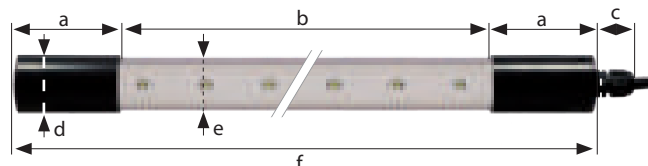

	3006	3012	3018	3024	3030
Gewicht   Weight	0,5kg	0,6kg	0,7kg	0,85kg	0,95kg

	a	b	c	d	e	f
KE-LED-EA 3006-P	60	210	20	33	30	325
KE-LED-EA 3012-P	60	425	20	33	30	540
KE-LED-EA 3018-P	60	640	20	33	30	755
KE-LED-EA 3024-P	60	855	20	33	30	970
KE-LED-EA 3030-P	60	1070	20	33	30	1185

## ZUBEHÖR | ACCESSORIES



# KE-LED-EA 40..-P MOD 24 | LED ROHRLEUCHTE | LED TUBE LUMINAIRE

## Merkmale | Features

6-30  
POWER  
LED

24V

IP65

H05  
RN-F

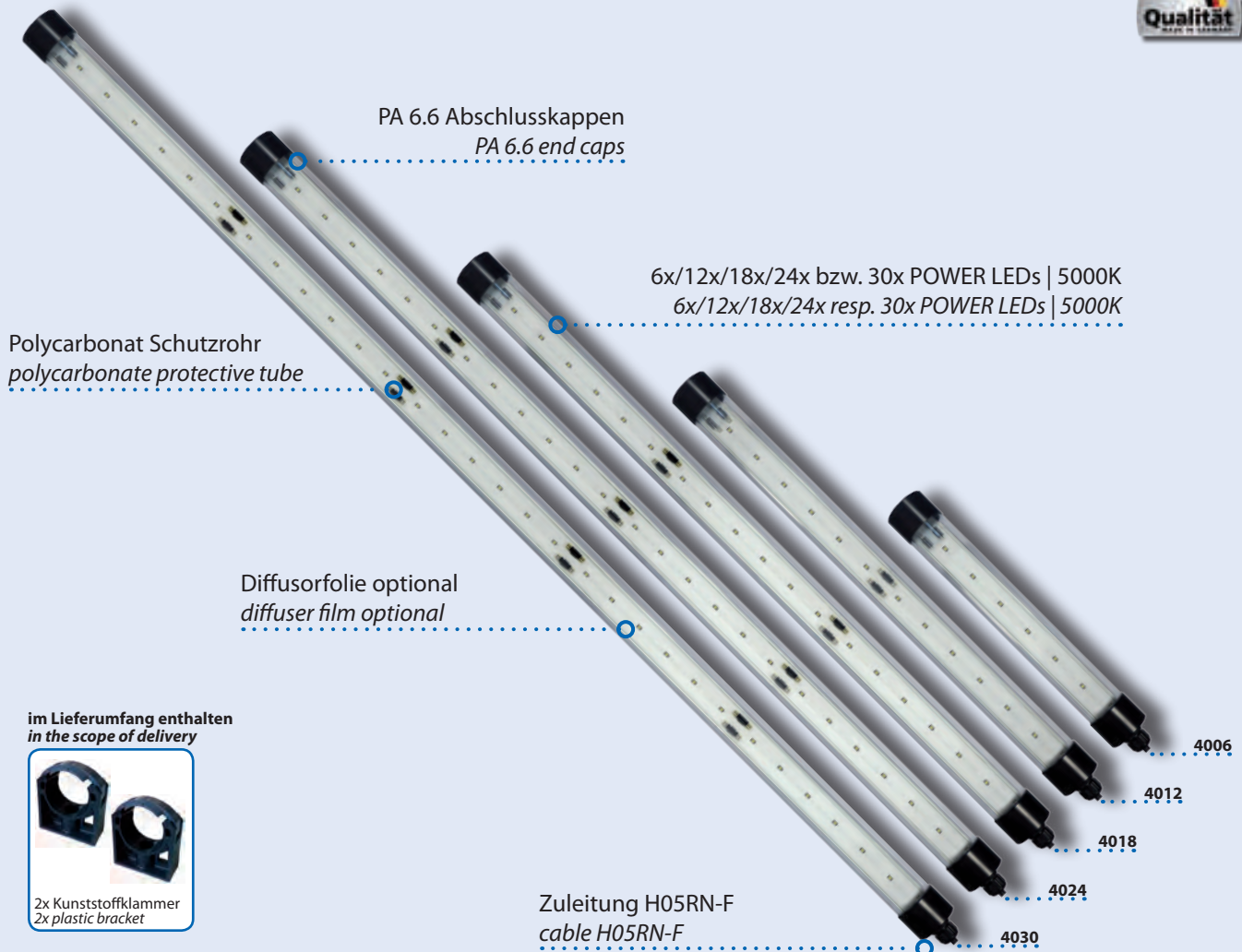

PA 6.6 Abschlusskappen  
*PA 6.6 end caps*

6x/12x/18x/24x bzw. 30x POWER LEDs | 5000K  
*6x/12x/18x/24x resp. 30x POWER LEDs | 5000K*

Polycarbonat Schutzrohr  
*polycarbonate protective tube*

Diffusorfolie optional  
*diffuser film optional*

im Lieferumfang enthalten  
*in the scope of delivery*



2x Kunststoffklammer  
*2x plastic bracket*

Zuleitung H05RN-F  
*cablE H05RN-F*



## VORTEILE | ADVANTAGES

- schlanke Bauform, ideal bei engen Einbauverhältnissen
- verschiedene Längen in gleichem Design
- ohne externes Vorschaltgerät einsetzbar
- *slim design, ideal for tight installation conditions*
- *different lengths in the same design*
- *can be used without an external ballast*

## EINSATZBEREICHE | AREAS OF APPLICATION

- Maschinenbau
- Schaltanlagenbau
- Hebebühnen / KFZ-Gruben
- *mechanical engineering*
- *switchgear manufacturing*
- *lifting platforms / car pits*

# KE-LED-EA 40..-P MOD 24 | LED ROHRLEUCHTE | LED TUBE LUMINAIRE



## LED Rohrleuchte mit bis zu 30 POWER LEDs. Modulare Bauweise - verschiedenen Längen erhältlich.

- Leuchtmittel: 6/12/18/24 bzw. 30 POWER LEDs / 5000 K
- Schutzrohr: Polycarbonat, 40mm Ø
- Abschlusskappen: PA 6.6, schwarz
- Befestigung: 2x Kunststoffklammer
- Schutzart: IP65
- Schutzklasse: III
- Zuleitung: 5m H05RN-F 2 x 1,00mm<sup>2</sup>
- Spannungsvariante: 24V
- Längere Zuleitung, Kabeltyp, Stecker auf Anfrage



## LED tube luminaire with up to 30 POWER LED. Modular construction - available in different length.

- Illuminant: 6/12/18/24 resp. 30 POWER LEDs / 5000 K
- Protective tube: polycarbonate, 40mm Ø
- End caps: PA 6.6, black
- Fixation: 2x plastic bracket
- Protection category: IP65
- Protection class: III
- Cable: 5m H05RN-F 2 x 1,00mm<sup>2</sup>
- Voltage variant: 24V
- Longer cable, cable type, plug etc. on request

### TECHNISCHE DATEN | TECHNICAL DATA

Art.-Nr.   Art.-No.	131802	131803	131804	131805	131806
Nennspannung   Nominal voltage	24V AC/DC	24V AC/DC	24V AC/DC	24V AC/DC	24V AC/DC
Strom   Current	0,19 A	0,35 A	0,61 A	0,75 A	0,75 A
Schutzklasse   Protection class	III	III	III	III	III
Anzahl LED   Number LED	6	12	18	24	30
Leistung   Power	5,5 W	10 W	15 W	20,7 W	20,7 W
Nutzlicht   Real lumen	570 Lm	1030 Lm	1740 Lm	2200 Lm	2200 Lm
Leuchte Energieeffizienzklasse Luminaire energy efficiency class					
Farbtemperatur   Color temperature	5000 K				
Farbwiedergabe   Color rendering	> 80				
Lebensdauer LED   Lifetime LED	> 50.000 h				
Umgebungstemp.   Ambient temp.	-20°C - +40°C				
IP Schutzart   IP protection class	IP65				
Diffusor   Diffuser	optional				
Schutzrohr   Protective tube	Polycarbonat				
Abschlusskappen   End caps	PA 6.6				
Zuleitung   Cable	5m H05RN-F 2 x 1,00mm <sup>2</sup>				
Stecker   Plug	optional				

### ABMESSUNGEN | DIMENSIONS (IN MM)

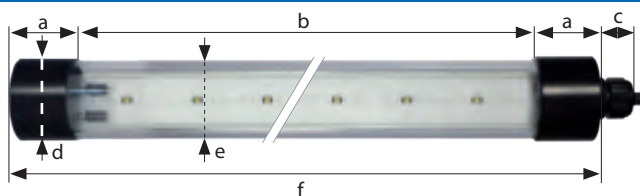

	4006	4012	4018	4024	4030
Gewicht   Weight	0,5kg	0,56kg	0,6kg	0,65kg	0,7kg

	a	b	c	d	e	f
KE-LED-EA 4006-P	30	235	20	43	40	295
KE-LED-EA 4012-P	30	450	20	43	40	510
KE-LED-EA 4018-P	30	665	20	43	40	725
KE-LED-EA 4024-P	30	880	20	43	40	940
KE-LED-EA 4030-P	30	1095	20	43	40	1155

### ZUBEHÖR | ACCESSORIES



# KE-LED-EA 40.-P MOD 230/110 | LED ROHRLEUCHE | LED TUBE LUMINAIRE

## Merkmale | Features

6-30 POWER LED 230V 110V IP65 H05 RN-F

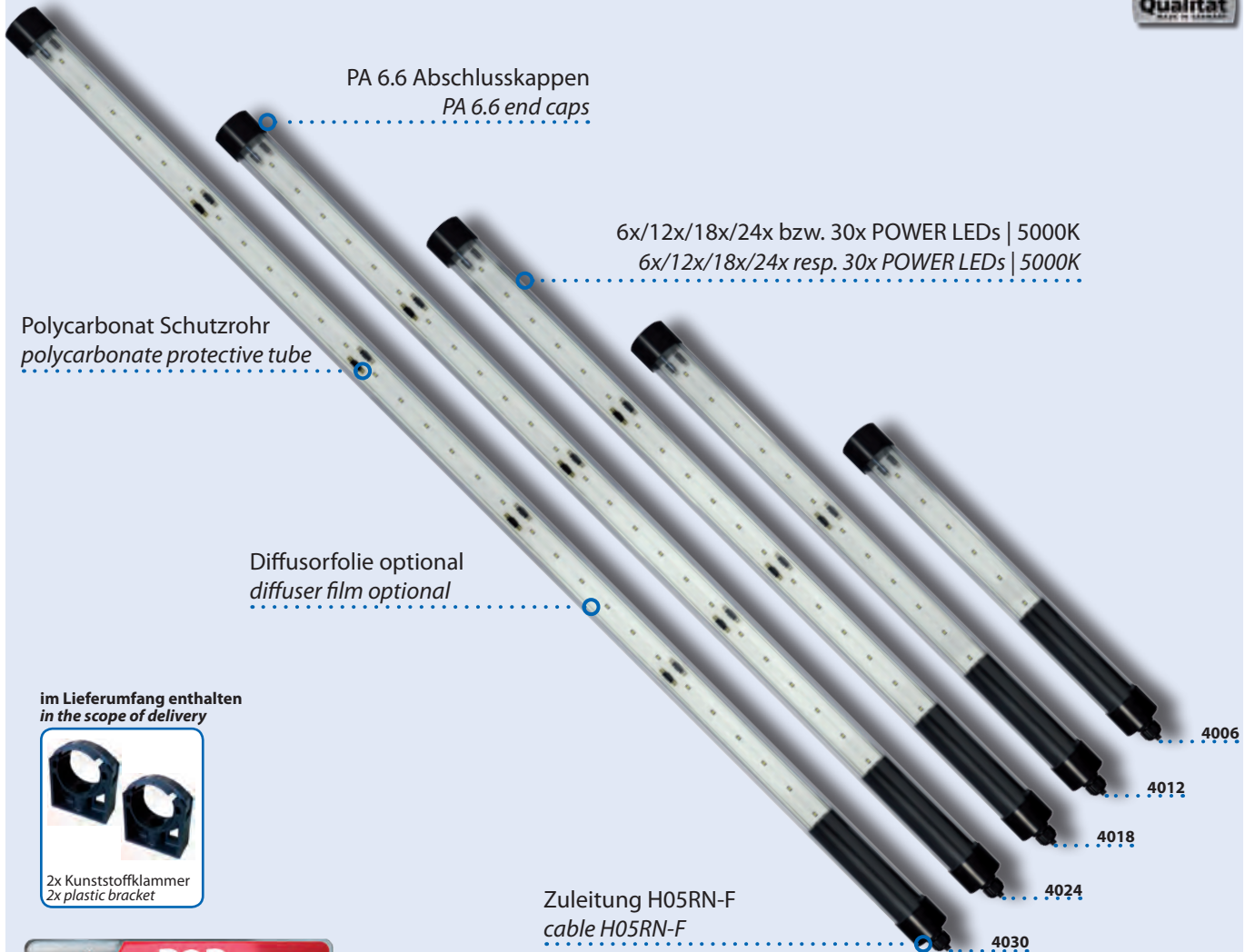

## VORTEILE | ADVANTAGES

- schlanke Bauform, ideal bei engen Einbauverhältnissen
- verschiedene Längen in gleichem Design
- ohne externes Vorschaltgerät einsetzbar
- *slim design, ideal for tight installation conditions*
- *different lengths in the same design*
- *can be used without an external ballast*

## EINSATZBEREICHE | AREAS OF APPLICATION

- Maschinenbau
- Lüftungs- und Klimagerätebau
- Hebebühnen / KFZ-Gruben
- *mechanical engineering*
- *ventilation and air-conditioning*
- *lifting platforms / car pits*

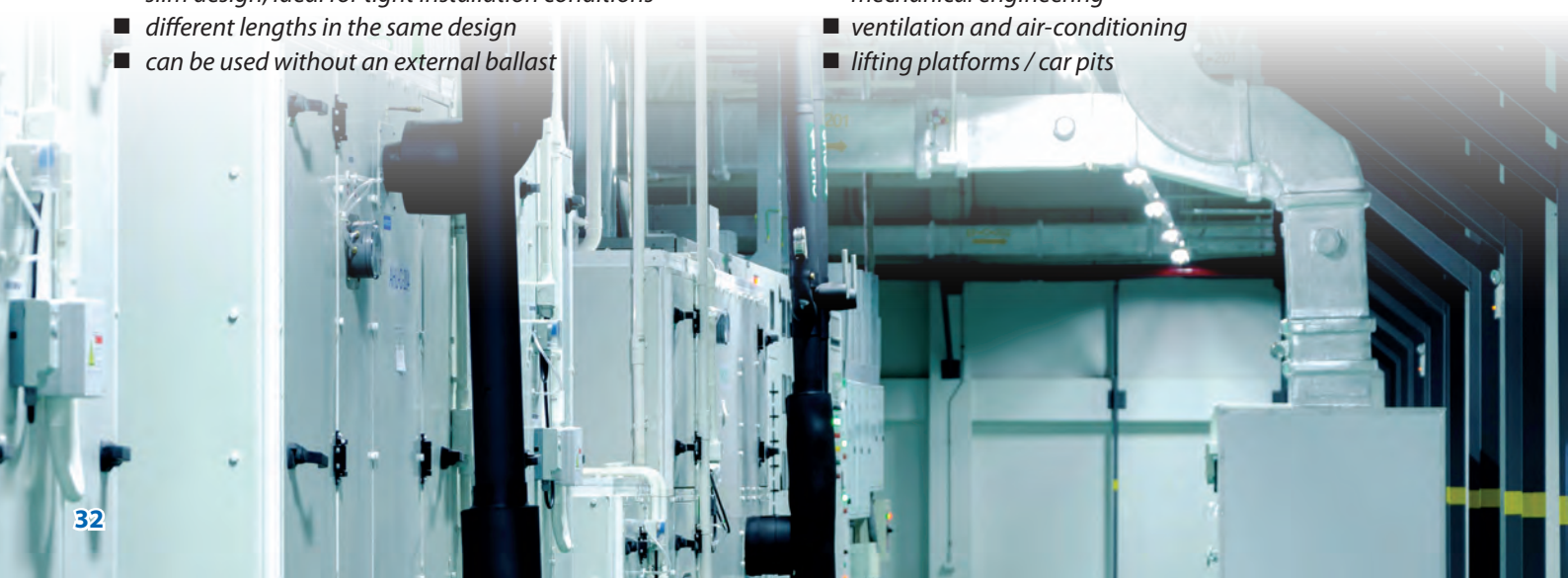



# KE-LED-EA 40..-P MOD 230/110 | LED ROHRLEUCHTE | LED TUBE LUMINAIRE



**LED Rohrleuchte mit bis zu 30 POWER LEDs. Modulare Bauweise - in verschiedenen Längen erhältlich.**

- Leuchtmittel: 6/12/18/24 bzw. 30 POWER LEDs / 5000 K
- Schutzrohr: Polycarbonat, 40mm Ø
- Abschlusskappen: PA 6.6, schwarz
- Befestigung: 2x Kunststoffklammer
- Schutzart: IP65
- Schutzklasse: II
- Zuleitung: 5m H05RN-F 2 x 1,00mm<sup>2</sup>
- Spannungsvarianten: 230V / 110V
- Längere Zuleitung, Kabeltyp, Stecker auf Anfrage



**LED tube luminaire with up to 30 POWER LED. Modular construction - available in different length.**

- Illuminant: 6/12/18/24 resp. 30 POWER LEDs / 5000 K
- Protective tube: Polycarbonat, 40mm Ø
- End caps: PA 6.6, black
- Fixation: 2x plastic bracket
- Protection category: IP65
- Protection class: II
- Cable: 5m H05RN-F 2 x 1,00mm<sup>2</sup>
- Voltage variants: 230V / 110V
- Longer cable, cable type, plug etc. on request

## TECHNISCHE DATEN | TECHNICAL DATA

	KE-LED-EA 4006		KE-LED-EA 4012		KE-LED-EA 4018		KE-LED-EA 4024		KE-LED-EA 4030	
<b>Art.-Nr.   Art.-No.</b>	<b>131790</b>	<b>131796</b>	<b>131791</b>	<b>131797</b>	<b>131792</b>	<b>131798</b>	<b>131793</b>	<b>131799</b>	<b>131794</b>	<b>131800</b>
Nennspannung   Nominal voltage	230V	110V	230V	110V	230V	110V	230V	110V	230V	110V
Strom   Current	0,035A	0,050A	0,065A	0,110A	0,090A	0,150A	0,110A	0,200A	0,120A	0,215A
Schutzklasse   Protection class	II	II	II	II	II	II	II	II	II	II
Anzahl LED   Number LED	6	6	12	12	18	18	24	24	30	30
Leistung   Power	5W	5W	12W	11,7W	16W	16W	21W	21W	25W	23W
Nutzlicht   Real lumen	440Lm	440Lm	1200Lm	1190Lm	1680Lm	1680Lm	2270Lm	2250Lm	2700Lm	2480Lm
Leuchte Energieeffizienzklasse Luminaire energy efficiency class										
Farbtemperatur   Color temperature	5000K									
Farbwiedergabe   Color rendering	> 80									
Lebensdauer LED   Lifetime LED	> 50.000 h									
Umgebungstemp.   Ambient temp.	-20°C - +40°C									
IP Schutzart   IP protection class	IP65									
Diffusor   Diffuser	optional									
Schutzrohr   Protective tube	Polycarbonat									
Abschlusskappen   End caps	PA 6.6									
Zuleitung   Cable	5m H05RN-F 2 x 1,00mm <sup>2</sup>									
Stecker   Plug	optional									

## ABMESSUNGEN | DIMENSIONS (IN MM)

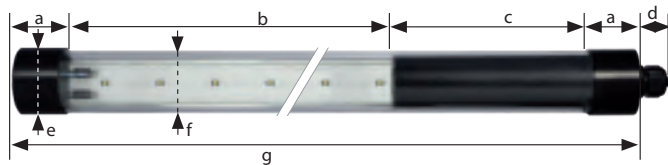

	4006	4012	4018	4024	4030
Gewicht   Weight	0,65kg	0,75kg	0,85kg	0,95kg	1,05kg

	a	b	c	d	e	f	g
KE-LED-EA 4006-P	30	230	120	20	43	40	410
KE-LED-EA 4012-P	30	440	120	20	43	40	620
KE-LED-EA 4018-P	30	650	120	20	43	40	830
KE-LED-EA 4024-P	30	860	120	20	43	40	1040
KE-LED-EA 4030-P	30	1070	120	20	43	40	1250

## ZUBEHÖR | ACCESSORIES



# KE-LED-EA 4010-P / HB | LED ROHRLEUCHE | LED TUBE LUMINAIRE

## Merkmale | Features



Abschlussstopfen Hart-PVC  
*closing plug hard PVC*

PMMA Schutzrohr  
*PMMA protective tube*

10x POWER LEDs | 5000K  
*10x POWER LEDs | 5000K*

Version ohne Ein-/Ausshalter  
*version without on/off switch*

Diffusorfolie integriert  
*integrated diffuser film*

im Lieferumfang enthalten  
*in the scope of delivery*



2x Kunststoffklammer  
*2x plastic bracket*

Version mit Ein-/Ausshalter  
*version with on/off switch*

Zuleitung H05RN-F  
*cable H05RN-F*



## VORTEILE | ADVANTAGES

- kompakte Bauform & hohe Lichtleistung
- wahlweise mit oder ohne Schalter
- in verschiedenen Spannungsvarianten erhältlich
- *compact design & high light output*
- *either with or without a switch*
- *available in different voltage versions*

## EINSATZBEREICHE | AREAS OF APPLICATION

- Maschinenbau / Schaltanlagenbau
- Fahrzeugbau
- *mechanical engineering / switchgear construction*
- *vehicle construction*



# KE-LED-EA 4010-P / HB | LED ROHRLEUCHE | LED TUBE LUMINAIRE



## LED Rohrleuchte für Maschinen, Fahrzeuge und Geräte aller Art.

- Leuchtmittel: 10 POWER LEDs / 5000 K
- Schutzrohr: PMMA, 40mm Ø
- Abschlussstopfen: Hart-PVC
- Befestigung: 2x Kunststoffklammer
- Schutzart: IP65
- Schutzklasse: II bzw. III
- Zuleitung: 5m H05RN-F 2 x 1,00mm<sup>2</sup>
- Spannungsvarianten: 230V / 110V / 42V / 24V
- Längere Zuleitung, Kabeltyp, Stecker auf Anfrage



## LED tube luminaire for the integration in machines, vehicles and all kind of devices.

- Illuminant: 10 POWER LEDs / 5000 K
- Protective tube: PMMA, 40mm Ø
- End plugs: Hard-PVC
- Fixation: 2x plastic bracket
- Protection category: IP65
- Protection class: II resp. III
- Cable: 5m H05RN-F 2 x 1,00mm<sup>2</sup>
- Voltage variants: 230V / 110V / 42V / 24V
- Longer cable, cable type, plug etc. on request

### TECHNISCHE DATEN | TECHNICAL DATA

Art.-Nr.   Art.-No. (ohne Schalter   w/o switch)	131324	131325	131326	131339
Art.-Nr.   Art.-No. (mit Schalter   with switch)	131414	131433	131434	131323
Nennspannung   Nominal voltage	220-240V AC	110V AC/DC	42V AC/DC	24V AC/DC
Strom   Current	0,04 A	0,085 A	0,165 A	0,32 A
Schutzklasse   Protection class	II	II	III	III
Anzahl LED   Number LED	10	10	10	10
Leistung   Power	6,7 W	6,5 W	8 W	8,5 W
Nutzlicht   Real lumen	670 Lm	700 Lm	800 Lm	820 Lm
Leuchte Energieeffizienzklasse Luminaire energy efficiency class				
Farbtemperatur   Color temperature	5000 K			
Farbwiedergabe   Color rendering	> 80			
Lebensdauer LED   Lifetime LED	> 50.000 h			
Umgebungstemp.   Ambient temp.	-20°C - +40°C			
IP Schutzart   IP protection class	IP65			
Diffusor   Diffuser	ja   yes			
Schutzrohr   Protective tube	PMMA			
Abschlussstopfen   End plugs	Hart-PVC			
Zuleitung   Cable	5m H05RN-F 2 x 1,00mm <sup>2</sup>			
Stecker   Plug	optional			

### ABMESSUNGEN | DIMENSIONS (IN MM)

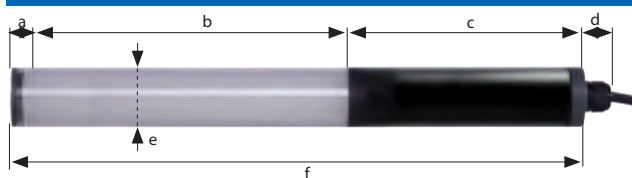

KE-LED-EA 4010-P / HB

a	b	c	d	e	f
25	200	155	20	40	380

Gewicht | Weight: ca. 0,5kg

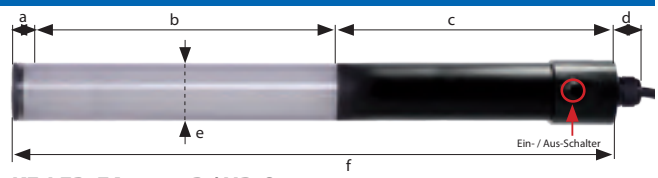

KE-LED-EA 4010-P / HB-S

a	b	c	d	e	f
25	200	190	20	40	415

Gewicht | Weight: ca. 0,5kg

### ZUBEHÖR | ACCESSORIES



# KE-LED-EA 5030-P | LED ROHRLEUCHE | LED TUBE LUMINAIRE

## Merkmale | Features



Abschlusskappen PVC  
end caps PVC

30x POWER LEDs | 5000K  
30x POWER LEDs | 5000K

Polycarbonat Schutzrohr  
polycarbonate protective tube

Diffusorfolie integriert  
integrated diffuser film

Standard-Version  
standard version

Version mit Durchgangsverdrahtung  
version with through-wiring

Zuleitung H07RN-F  
cable H07RN-F

### erhältliche Versionen available versions



mit Klammern  
with clamps



mit Aufhängehaken  
with suspension-hooks



Durchgangsverdrahtung  
through-wiring



Zeltleuchten-Set  
as a tent lamp set

### im Lieferumfang enthalten in the scope of delivery



Version mit Klammern:  
Version with brackets:  
2x Kunststoffklammer  
2x plastic bracket



Version m. Aufhängehaken:  
Version with hooks:  
2x Aufhängehaken  
2x suspensions hooks



## VORTEILE | ADVANTAGES

- universell einsetzbar, als festmontierte Leuchte oder als mobile Arbeitsleuchte
- als Durchgangsversion mehrere Leuchten verlinkbar
- can be used universally, as a fixed lamp or as a mobile work lamp
- several lights can be linked as a passage version

## EINSATZBEREICHE | AREAS OF APPLICATION

- Maschinen und Anlagen
- Inspektion und Servicarbeiten
- Tunnelbau / Wartung
- machinery and equipment
- inspection and servicing
- tunnel construction / maintenance

Standard   Standard	Volt	Art-Nr. m. Klammer with clamp	Art-No. mit Haken with hooks
KE-LED-EA 5030-P/230	230	131690	131650
KE-LED-EA 5030-P/110	110	131691	131651
KE-LED-EA 5030-P/42	42	131692	131667
KE-LED-EA 5030-P/24	24	131693	131653

Durchgang   through-wiring	Volt	Art-Nr. m. Klammer with clamp	Art-No. mit Haken with hooks
KE-LED-EA 5030-P/230-D	230	131694	131381
KE-LED-EA 5030-P/110-D	110	131695	131382
KE-LED-EA 5030-P/42-D	42	131696	131383
KE-LED-EA 5030-P/24-D	24	131697	131384

# KE-LED-EA 5030-P | LED ROHRLEUCHE | LED TUBE LUMINAIRE



**LED Leuchte mit 30 POWER LEDs. Mittels optionaler Durchgangsverdrahtung ideal als Reihenbeleuchtung.**

- Leuchtmittel: 30 POWER LEDs / 5000 K
- Schutzrohr: Polycarbonat, 50mm Ø
- Abschlusskappen: PVC
- Befestigung: 2x Kunststoffklammer bzw. Metallhaken
- Schutzart: IP65
- Schutzklasse: II bzw. III
- Zuleitung: 5m H07RN-F 2 x 1,00mm<sup>2</sup>
- Spannungsvarianten: 230V / 110V / 42V / 24V
- Längere Zuleitung, Kabeltyp, Stecker auf Anfrage



**LED lamp with 30 POWER LED. Optional by means of through-wiring ideal applicable as line illumination.**

- Illuminant: 30 POWER LEDs / 5000 K
- Protective tube: polycarbonate, 50mm Ø
- End caps: PVC
- Fixation: 2x plastic bracket resp. 2x metal hook
- Protection category: IP65
- Protection class: II resp. III
- Cable: 5m H07RN-F 2 x 1,00mm<sup>2</sup>
- Voltage variants: 230V / 110V / 42V / 24V
- Longer cable, cable type, plug etc. on request

## TECHNISCHE DATEN | TECHNICAL DATA

Nennspannung   Nominal voltage	220-240V AC	110V AC/DC	42V AC/DC	24V AC/DC
Strom   Current	0,125 A	0,185 A	0,390 A	0,7 A
Schutzklasse   Protection class	II	II	III	III
Anzahl LED   Number LED	30	30	30	30
Leistung   Power	25 W	20 W	20 W	21 W
Nutzlicht   Real lumen	2800 Lm	2380 Lm	2250 Lm	2300 Lm
Leuchte Energieeffizienzklasse Luminaire energy efficiency class				
Farbtemperatur   Color temperature	5000 K			
Farbwiedergabe   Color rendering	> 80			
Lebensdauer LED   Lifetime LED	> 50.000 h			
Umgebungstemp.   Ambient temp.	-20°C - +40°C			
IP Schutzart   IP protection class	IP65			
Diffusor   Diffuser	ja   yes			
Schutzrohr   Protective tube	Polycarbonat			
Abschlusskappen   End caps	PVC			
Zuleitung   Cable	Version: Standard: 5m / Durchgang: 5m/0,5m H07RN-F 2 x 1,00mm <sup>2</sup>			
Stecker   Plug	230V Version: ja   yes (110V / 42V / 24V optional)			

## ABMESSUNGEN | DIMENSIONS (IN MM)

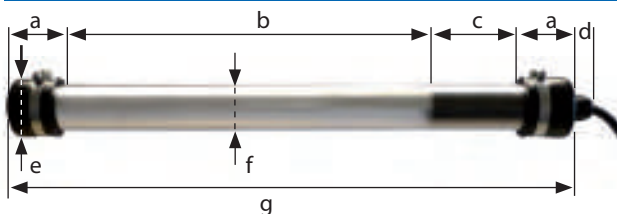

KE-LED-EA 5030-P (Standard)

a	b	c	d	e	f	g
50	670	120	25	50	50	890

Gewicht | Weight: ca. 1,5kg

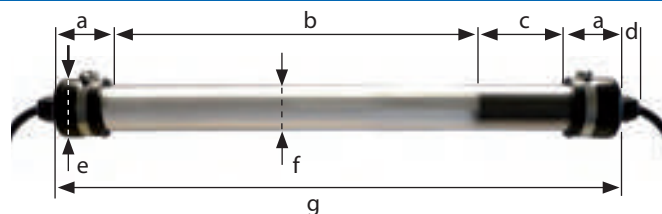

KE-LED-EA 5030-P (Durchgang)

a	b	c	d	e	f	g
50	670	160	25	50	50	930

Gewicht | Weight: ca. 1,5kg

## ZUBEHÖR | ACCESSORIES



# KE-LED-DW 63.. | LED ROHRLEUCHTE | LED TUBE LUMINAIRE

## Merkmale | Features



Abschlusskappen Neopren  
end caps neoprene

12x/24x bzw. 36x POWER LEDs | 5000K  
12x/24x resp. 36x POWER LEDs | 5000K

Polycarbonat Schutzrohr  
polycarbonate protective tube

### erhältliche Versionen available versions



**IP68** Standardkabelverschraubung mit Anschlussleitung.  
Standard cable gland with connecting cable.



**IP67** Schnellanschlussverschraubung für einfache & schnelle Montage.  
Quick connector for easy and fast luminaire mounting.



**IP65** Durchgangsverdrahtung zur Montage mehrerer Leuchten in Reihe.  
Through-wiring for linking several lamps.

### im Lieferumfang enthalten in the scope of delivery



2x Kunststoffklammer  
2x plastic bracket

Zuleitung H07RN-F  
cable H07RN-F



## VORTEILE | ADVANTAGES

- als Durchgangsversion mehrere Leuchten verlinkbar
- several lights can be linked as a passage version

## EINSATZBEREICHE | AREAS OF APPLICATION

- Maschinen und Anlagen
- machinery and equipment

VERSIONEN   VERSIONS	Art-Nr.	Art-Nr.	Art-Nr.	Art-Nr.
<b>STANDARD</b>	<b>230 Volt</b>	<b>110 Volt</b>	<b>42 Volt</b>	<b>24 Volt</b>
KE-LED-DW 6312 Standard / IP68	131720	131721	---	131723
KE-LED-DW 6324 Standard / IP68	131724	131725	131726	131727
KE-LED-DW 6336 Standard / IP68	131728	131729	131730	131731
<b>PHÖNIX</b>	<b>230 Volt</b>	<b>110 Volt</b>	<b>42 Volt</b>	<b>24 Volt</b>
KE-LED-DW 6312 Phönix / IP67	131740	131741	---	131743
KE-LED-DW 6324 Phönix / IP67	131744	131745	131746	131747
KE-LED-DW 6336 Phönix / IP67	131748	131749	131750	131751
<b>DURCHGANG   THROUGH-WIRING</b>	<b>230 Volt</b>	<b>110 Volt</b>	<b>42 Volt</b>	<b>24 Volt</b>
KE-LED-DW 6312 Durchgang / IP65	131760	131761	---	131763
KE-LED-DW 6324 Durchgang / IP65	131764	131765	131766	131767
KE-LED-DW 6336 Durchgang / IP65	131768	131769	131770	131771

# KE-LED-DW 63.. | LED ROHRLEUCHTE | LED TUBE LUMINAIRE



Die Leuchten aus der Serie KE-LED-DW 63xx sind aufgrund der unterschiedlich erhältlichen Versionen universell einsetzbar.

- Leuchtmittel: 12/24 bzw. 36 POWER LEDs / 5000 K
- Schutzrohr: Polycarbonat, 63mm Ø
- Abschlusskappen: Neopren
- Befestigung: 2x Kunststoffklammer
- Schutzart: IP65 / IP67 / IP68
- Schutzklasse: II bzw. III
- Zuleitung: 5m H07RN-F 2 x 1,00mm<sup>2</sup>
- Spannungsvarianten: 230V / 110V / 42V / 24V
- Längere Zuleitung, Kabeltyp, Stecker auf Anfrage



The luminaires from the KE-LED-DW 63xx series are universally applicable due to the different versions available.

- Illuminant: 12/24 resp. 36 POWER LEDs / 5000 K
- Protective tube: polycarbonate, 63mm Ø
- End caps: neoprene
- Fixation: 2x plastic bracket
- Protection category: IP65 / IP67 / IP68
- Protection class: II resp. III
- Cable: 5m H07RN-F 2 x 1,00mm<sup>2</sup>
- Voltage variants: 230V / 110V / 42V / 24V
- Longer cable, cable type, plug etc. on request

## TECHNISCHE DATEN | TECHNICAL DATA

	KE-LED-DW 6312			KE-LED-DW 6324				KE-LED-DW 6336			
Nennspannung   Nominal voltage	230V	110V	24V	230V	110V	42V	24V	230V	110V	42V	24V
Strom   Current	0,065A	0,11A	0,34A	0,125A	0,19A	0,40A	0,70A	0,125A	0,215A	0,39A	0,70A
Schutzklasse   Protection class	II	II	III	II	II	III	III	II	II	III	III
Anzahl LED   Number LED	12	12	12	24	24	24	24	36	36	36	36
Leistung   Power	12W	12W	10W	25W	21W	20,5W	20,8W	25W	23W	20W	20,6W
Nutzlicht (Lumen)   Real lumen	1180	1250	1100	2700	2350	2250	2230	2800	2700	2300	2200
Leuchte Energieeffizienzklasse Luminaire energy efficiency class											
Farbtemperatur   Color temperature	5000K										
Farbwiedergabe   Color rendering	> 80										
Lebensdauer LED   Lifetime LED	> 50.000 h										
Umgebungstemp.   Ambient temp.	-20°C - +40°C										
IP Schutzart   IP protection class	IP65 / IP67 / IP68 (versionsabhängig   version dependent)										
Diffusor   Diffuser	ja   yes										
Schutzrohr   Protective tube	Polycarbonat										
Abschlusskappen   End caps	Neopren										
Zuleitung   Cable	Standard Version: 5m H07RN-F 2 x 1,00mm <sup>2</sup> Phönix Version: ohne Zuleitung   w/o cable Durchgang-Version: 5m / 0,5m H07RN-F 2 x 1,00mm <sup>2</sup>										
Stecker   Plug	230V Version: ja   yes (110V / 42V / 24V optional)										

## ABMESSUNGEN | DIMENSIONS (IN MM)

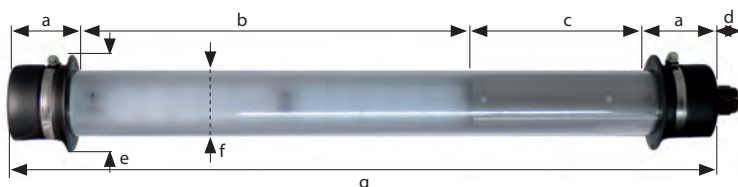

	a	b	c	d	e	f	g
KE-LED-DW 6312	55	195	175	20	90	50	500
KE-LED-DW 6324	55	375	175	20	90	50	680
KE-LED-DW 6336	55	555	175	20	90	50	860

## ZUBEHÖR | ACCESSORIES



# KE-LED 5045/230-M | LED ROHRLEUCHTE | LED TUBE LUMINAIRE

## Merkmale | Features

288x LED 230V IP54 H07 RN-F



Metallhaken, drehbar  
*metall hook, rotatable*

288x LEDs - 360° Ausleuchtung | 4100K  
*288x LEDs - 360° illumination | 4100K*

Polycarbonat Schutzrohr, opal matt  
*polycarbonate protective tube, opal matt*

Metallstandfuß optional  
*metal stand optional*



Abschlusskappen PVC  
*end caps PVC*

Zuleitung H07RN-F  
*cabl e H07RN-F*



## VORTEILE | ADVANTAGES

- 360° Ausleuchtung / hohe Lichtleistung
- variabel einsetzbar mittels Aufhängehaken oder optional erhältlichem Standfuß
- 360° illumination / high light output
- can be used variably using a hanging hook or an optionally available stand

## EINSATZBEREICHE | AREAS OF APPLICATION

- Baustellen
- Maler und Gipsler Gewerbe
- building site
- painter and plasterer trade

LED  
360°



# KE-LED 5045/230-M | LED ROHRLEUCHTE | LED TUBE LUMINAIRE



**Universelle LED Leuchte mit 288 Hochleistungs-LEDs. Ideal für den Einsatz im Baugewerbe und Malerhandwerk. Blendfreies Licht, 360° rundstrahlend.**

- Leuchtmittel: 288 Hochleistungs-LEDs / 4100 K
- Schutzrohr: Polycarbonat, opal matt, 50mm Ø
- Abschlusskappen: Weich-PVC, schwarz
- Befestigung: Aufhängehaken aus Metall
- Schutzart: IP54
- Schutzklasse: II
- Zuleitung: 10m H07RN-F 2 x 1,00mm<sup>2</sup>
- Spannungsvariante: 230V
- Längere Zuleitung, Kabeltyp, Stecker auf Anfrage



**Universal LED lamp with 288 high-performance LEDs. Ideal for use in the building industry and painting craft. Dazzle-free light, 360° round light.**

- Illuminant: 288 high-performance LEDs / 4100 K
- Protective tube: polycarbonate, opal matt, 50mm Ø
- End caps: soft-PVC, black
- Fixation: rotatable suspension hook made of metal
- Protection category: IP54
- Protection class: II
- Cable: 10m H07RN-F 2 x 1,00mm<sup>2</sup>
- Voltage variant: 230V
- Longer cable, cable type, plug etc. on request

## TECHNISCHE DATEN | TECHNICAL DATA

<b>Art.-Nr.   Art.-No.</b>	<b>117008</b>
Nennspannung   <i>Nominal voltage</i>	230V
Strom   <i>Current</i>	0,21 A
Schutzklasse   <i>Protection class</i>	II
Anzahl LED   <i>Number LED</i>	288
Leistung   <i>Power</i>	47 W
Nutzlicht   <i>Real lumen</i>	6200 Lm
Leuchte Energieeffizienzklasse <i>Luminaire energy efficiency class</i>	
Farbtemperatur   <i>Color temperature</i>	4100 K
Farbwiedergabe   <i>Color rendering</i>	> 80
Lebensdauer LED   <i>Lifetime LED</i>	> 50.000 h
Umgebungstemp.   <i>Ambient temp.</i>	-20°C - +40°C
IP Schutzart   <i>IP protection class</i>	IP54
Schutzrohr   <i>Protective tube</i>	Polycarbonat, opal matt
Abschlusskappen   <i>End caps</i>	PVC
Zuleitung   <i>Cable</i>	10m H07RN-F 2 x 1,00mm <sup>2</sup>
Stecker   <i>Plug</i>	ja   yes

## ABMESSUNGEN | DIMENSIONS (IN MM)

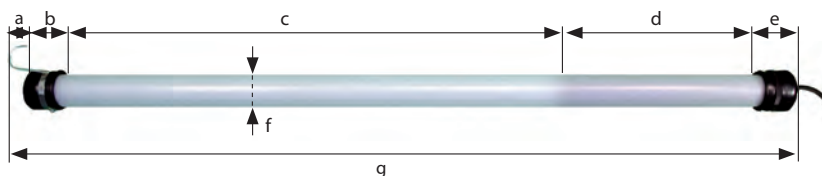

a	b	c	d	e	f	g
40	50	800	325	55	50	1270

Gewicht | *Weight*: ca. 2,0kg

## ZUBEHÖR STA-50 | ACCESSORIES STA-50



<b>Art.-Nr.   Art.-No.</b>	<b>291392</b>
Material   <i>Material</i>	Eisen, verzinkt   <i>Galvanized iron</i>
Befestigung   <i>Fixation</i>	2x Klammer   <i>2x bracket</i>
Höhe   <i>Height</i>	435mm
Gewicht   <i>Weight</i>	1,8kg

## ZUBEHÖR | ACCESSORIES

STECKER   PLUGS			Art.-Nr.
BS Gummischutzkontaktstecker   <i>Rubber protective contact plug</i>	230V / 3 pol.		290052
SOE Gummikonturenstecker   <i>Rubber contour plug</i>	230V / 2 pol.		291141
CEE-ST CEE-Stecker 230V   <i>CEE-plug 230V</i>	16A / 3 pol.		290171
CEE-ST CEE-Stecker 110V   <i>CEE-plug 110V</i>	16A / 3 pol.		290724
CEE-ST CEE-Stecker 42V   <i>CEE-plug 42V</i>	16A / 2 pol.		290089
CEE-ST CEE-Stecker 24V   <i>CEE-plug 24V</i>	16A / 2 pol.		290108
A-Autouniversalstecker   <i>A-car universal plug</i>			291730
ADIN-Autostecker DIN 4165   <i>ADIN-car plug DIN 4165</i>			290083
KUPPLUNGEN   COUPLINGS			Art.-Nr.
BK Gummi-Schutzkont.-Kupplung   <i>Rubber protective contact coupling</i>	230V / 3 pol.		290291
CEE-ST CEE-Kupplung 230V   <i>CEE-coupling 230V</i>	16A / 3 pol.		290327
CEE-ST CEE-Kupplung 110V   <i>CEE-coupling 110V</i>	16A / 3 pol.		290328
CEE-ST CEE-Kupplung 42V   <i>CEE-coupling 42V</i>	16A / 2 pol.		290088
CEE-ST CEE-Kupplung 24V   <i>CEE-coupling 24V</i>	16A / 2 pol.		290292
BEFESTIGUNGSKLAMMERN   MOUNTING BRACKETS			Art.-Nr.
BFK D40 Kunststoffklammer   <i>plastic bracket</i>	für Leuchten Ø   <i>for lamp Ø : 40mm</i>		290056
BFK D50 Kunststoffklammer   <i>plastic bracket</i>	für Leuchten Ø   <i>for lamp Ø : 50mm</i>		290057
BFK D63 Kunststoffklammer   <i>plastic bracket</i>	für Leuchten Ø   <i>for lamp Ø : 63mm</i>		290058
MAGNETBEFESTIGUNG   MAGNETIC ATTACHEMENT			Art.-Nr.
KM 10 Magnet m. Federstahlklammer   <i>magnet w. spring steel clamp</i>	Kraft   <i>force: 10kg</i>	Leuchten   <i>lamp Ø: 30mm</i>	290498
KM 20 Magnet m. Federstahlklammer   <i>magnet w. spring steel clamp</i>	Kraft   <i>force: 20kg</i>	Leuchten   <i>lamp Ø: 30mm</i>	290499
KM 30 Magnet m. Federstahlklammer   <i>magnet w. spring steel clamp</i>	Kraft   <i>force: 30kg</i>	Leuchten   <i>lamp Ø: 30mm</i>	290500
KM 40 Magnet m. Klammer BFK D40   <i>magnet w. clamp BFK D40</i>	Kraft   <i>force: 60kg</i>	Leuchten   <i>lamp Ø: 40mm</i>	291600
KM 50 Magnet m. Klammer BFK D50   <i>magnet w. clamp BFK D50</i>	Kraft   <i>force: 60kg</i>	Leuchten   <i>lamp Ø: 50mm</i>	290750
KM 63 Magnet m. Klammer BFK D63   <i>magnet w. clamp BFK D63</i>	Kraft   <i>force: 60kg</i>	Leuchten   <i>lamp Ø: 63mm</i>	290503
AUFHÄNGEHAKEN   HANGING HOOK			Art.-Nr.
AH 70 Aufhängehaken INOX   <i>suspension hook INOX</i>	für Leuchten   <i>for lamps: KE-LED-DW 63xx / KE-LED-EA 5030</i>		290097
KLARSICHT-SCHUTZFOLIEN (HANDLEUCHTEN)   PROTECTIVE FOILS (HAND LAMPS)			Art.-Nr.
SFO-LED 4010 - für Handleuchte KE-LED-4010   <i>for hand lamp KE-LED 4010</i>			292700
SFO-LED 5024 - für Handleuchte KE-LED-5024   <i>for hand lamp KE-LED 5024</i>			291996
SFO-LED 5030 - für Handleuchte KE-LED-5030   <i>for hand lamp KE-LED 5030</i>			291995
KLARSICHT-SCHUTZFOLIEN (ROHRLEUCHTEN)   PROTECTIVE FOILS (TUBE LUMINAIRES)			Art.-Nr.
SFO-LED-EA 5030 - für Rohrleuchte   <i>for tube luminaire: KE-LED-EA 5030-P</i>			291995
SFO-LED-DW 6312 - für Rohrleuchte   <i>for tube luminaire: KE-LED-DW 6312</i>			292701
SFO-LED-DW 6324 - für Rohrleuchte   <i>for tube luminaire: KE-LED-DW 6324</i>			292702
SFO-LED-DW 6336 - für Rohrleuchte   <i>for tube luminaire: KE-LED-DW 6336</i>			292703
SFO-LED-MOD 4006/4012 - für Rohrleuchte   <i>for tube luminaire: KE-LED-EA 4006 / 4012 modular</i>			292704
SFO-LED-MOD 4018/4024 - für Rohrleuchte   <i>for tube luminaire: KE-LED-EA 4018 / 4024 modular</i>			292705
SFO-LED-MOD 4030 - für Rohrleuchte   <i>for tube luminaire: KE-LED-EA 4030 modular</i>			292706
DIFFUSORFOLIE   DIFFUSER FOIL			Art.-Nr.
Diffusor 4006 - für KE-LED-EA 4006 modular   <i>for KE-LED-EA 4006 modular</i>			291691
Diffusor 4012/4018 - für KE-LED-EA 4012/4018 modular   <i>for KE-LED-EA 4012/4018 modular</i>			291692
Diffusor 4024/4030 - für KE-LED-EA 4024/4030 modular   <i>for KE-LED-EA 4024/4030 modular</i>			291693

# KIRA LED Arbeitsplatzleuchten - Einsatzgebiete

## *KIRA LED workplace lights - areas of application*



# KE-LED 3003-P/A-.. | LED ARBEITSPLATZLEUCHE | LED WORKPLACE LAMP

## Merkmale | Features

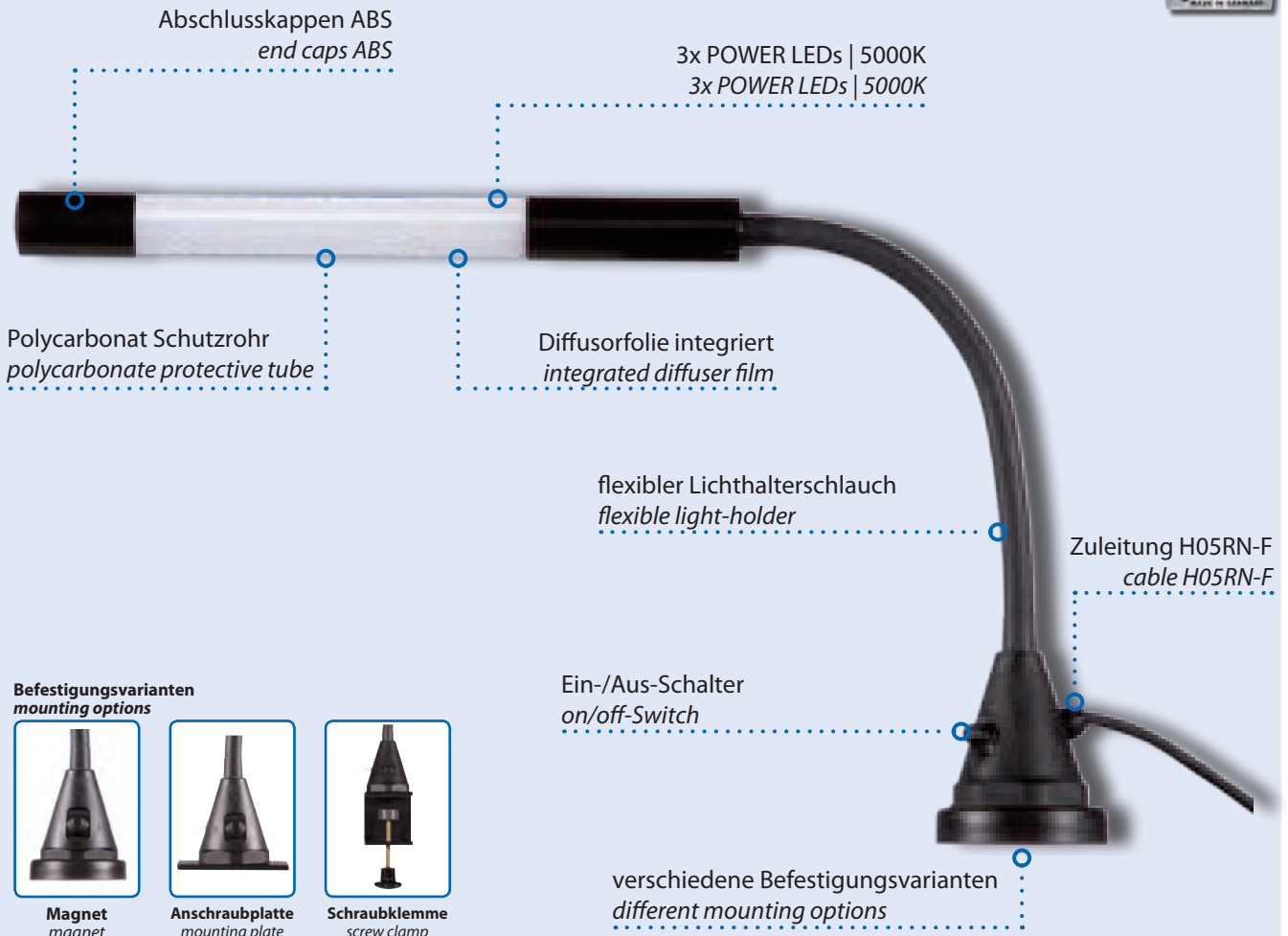

### Befestigungsvarianten *mounting options*



**Magnet**  
*magnet*



**Anschraubplatte**  
*mounting plate*



**Schraubklemme**  
*screw clamp*



## VORTEILE | ADVANTAGES

- flexibler Lichthalterschlauch zur optimalen Ausrichtung des Leuchtenkopfs
- blendfreies Licht dank Prismenschutzrohr
- verschiedene Befestigungsvarianten erhältlich
- *flexible light holder tube for optimal alignment of the lamp head*
- *glare-free light thanks to prism protection tube*
- *various mounting variants available*

## EINSATZBEREICHE | AREAS OF APPLICATION

- Werkbänke, Maschinen und Anlagen
- CNC- und Bohrmaschinen
- Laborarbeitsplätze
- *workbenches and machines*
- *CNC and drilling machines*
- *laboratory workstations*

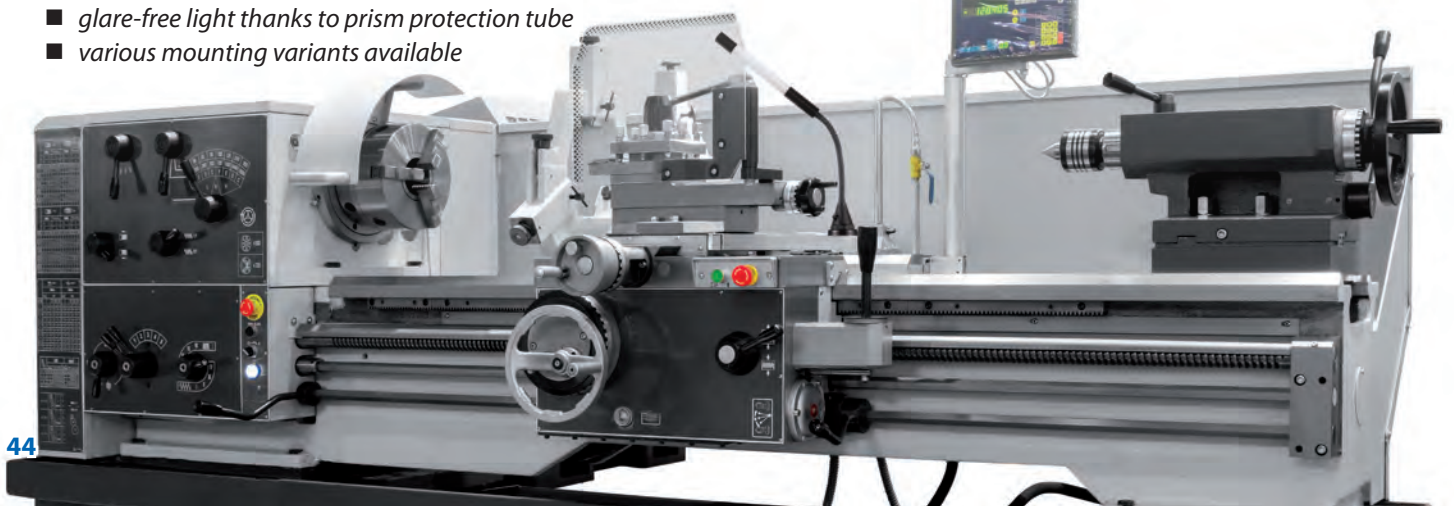

# KE-LED 3003-P/A-.. | LED ARBEITSPLATZLEUCHE | LED WORKPLACE LAMP



## LED Arbeitsplatzleuchte mit flexiblem Lichthalterschlauch.

- Leuchtmittel: 3 POWER LEDs / 5000 K
- Schutzrohr: Polycarbonat, 30mm Ø
- Abschlusskappen: ABS, schwarz
- Flexibler Lichthalterschlauch: 300mm (opt. 400 o. 500mm)
- Befestigung: Magnet, Anschraubplatte oder Schraubklemme
- Schutzart: IP54
- Schutzklasse: II bzw. III
- Zuleitung: 5m H05RN-F 2 x 1,00mm<sup>2</sup>
- Spannungsvarianten: 230V / 24V



## LED workplace lamp with flexible light holder tube.

- Illuminant: 3 POWER LEDs / 5000 K
- Protective tube: polycarbonate, 30mm Ø
- End caps: ABS, black
- Flexible light holder: 300mm (opt. 400 or 500mm)
- Fixation: magnet, mounting plate or screw clamp
- Protection category: IP54
- Protection class: II resp. III
- Cable: 5m H05RN-F 2 x 1,00mm<sup>2</sup>
- Voltage variants: 230V / 24V

### TECHNISCHE DATEN | TECHNICAL DATA

		220-240V AC	24V AC/DC (12-24V)
Nennspannung   Nominal voltage		220-240V AC	24V AC/DC (12-24V)
Strom   Current		0,03 A	0,12 A
Schutzklasse   Protection class		II	III
Anzahl LED   Number LED		3	3
Leistung   Power		3,5 W	3,5 W
Nutzlicht   Real lumen		250 Lm	250 Lm
Leuchte Energieeffizienzklasse Luminaire energy efficiency class			
Farbtemperatur   Color temperature		5000 K	
Farbwiedergabe   Color rendering		> 80	
Lebensdauer LED   Lifetime LED		> 50.000 h	
Umgebungstemp.   Ambient temp.		-20°C - +40°C	
IP Schutzart   IP protection class		IP54	
Diffusor   Diffuser		ja   yes	
Schutzrohr   Protective tube		Polycarbonat	
Abschlusskappen   End caps		ABS (Kunststoff   plastic)	
Zuleitung   Cable		5m H05RN-F 2 x 1,00mm <sup>2</sup>	
Stecker   Plug		230V Version: ja   yes (24V optional)	

### MIT MAGNET | WITH MAGNET

	Art-Nr. / 230V	Art-Nr. / 24V
KE-LED 3003-P/A-M / 300mm Lichthalter   light holder	131333	131347
KE-LED 3003-P/A-M / 400mm Lichthalter   light holder	132013	131588
KE-LED 3003-P/A-M / 500mm Lichthalter   light holder	131390	131589

### MIT ANSCHRAUBPLATTE | WITH MOUNTING PLATE

	Art-Nr. / 230V	Art-Nr. / 24V
KE-LED 3003-P/A-P / 300mm Lichthalter   light holder	131332	131374
KE-LED 3003-P/A-P / 400mm Lichthalter   light holder	131590	131591
KE-LED 3003-P/A-P / 500mm Lichthalter   light holder	131447	131592

### MIT SCHRAUBKLEMME | WITH SCREW CLAMP

	Art-Nr. / 230V	Art-Nr. / 24V
KE-LED 3003-P/A-K / 300mm Lichthalter   light holder	131329	131344
KE-LED 3003-P/A-K / 400mm Lichthalter   light holder	131593	131595
KE-LED 3003-P/A-K / 500mm Lichthalter   light holder	131594	131596

### ABMESSUNGEN | DIMENSIONS (IN MM)

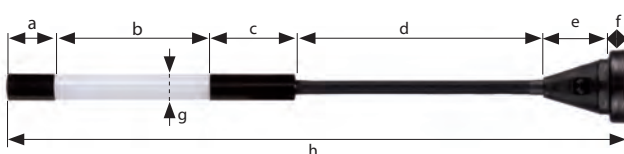

	a	b	c	d	e	f	g	h
mit 300mm Lichthalter   light holder	60	155	105	290	80	20	30	710
mit 400mm Lichthalter   light holder	60	155	105	390	80	20	30	810
mit 500mm Lichthalter   light holder	60	155	105	490	80	20	30	910

Gewicht | Weight: ca. 1,5kg

# KE-LED 3006-P/A-.. | LED ARBEITSPLATZLEUCHE | LED WORKPLACE LAMP

## Merkmale | Features

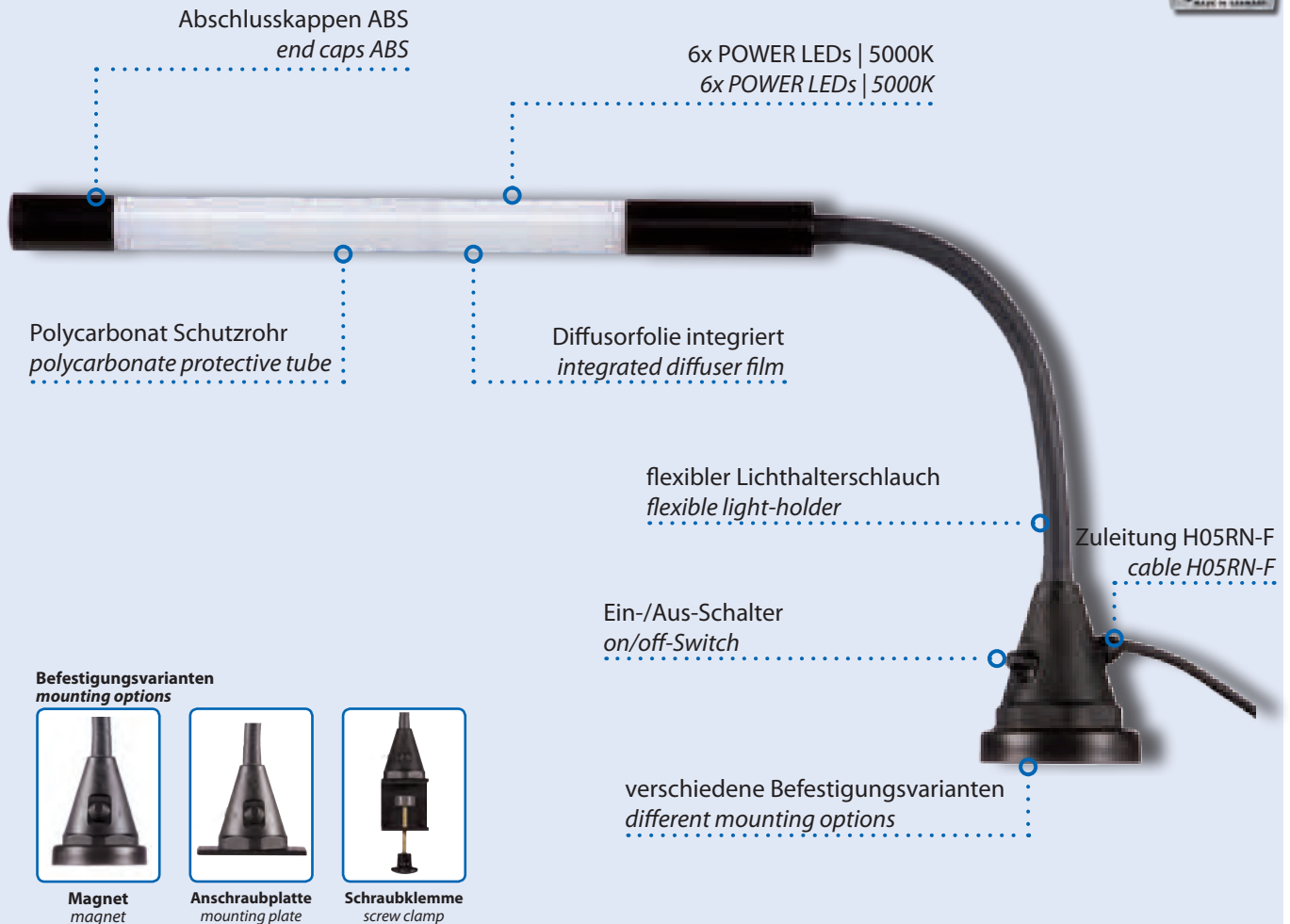

## VORTEILE | ADVANTAGES

- flexibler Lichthalterschlauch zur optimalen Ausrichtung des Leuchtenkopfs
- blendfreies Licht dank Diffusorfolie
- verschiedene Befestigungsvarianten erhältlich
- *flexible light holder tube for optimal alignment of the lamp head*
- *glare-free light thanks integrated diffuser foil*
- *various mounting variants available*

## EINSATZBEREICHE | AREAS OF APPLICATION

- Werkbänke, Maschinen und Anlagen
- CNC- und Bohrmaschinen
- Laborarbeitsplätze
- *workbenches and machines*
- *CNC and drilling machines*
- *laboratory workstations*

# KE-LED 3006-P/A-.. | LED ARBEITSPLATZLEUCHE | LED WORKPLACE LAMP



## LED Arbeitsplatzleuchte mit flexiblem Lichthalterschlauch.

- Leuchtmittel: 6 POWER LEDs / 5000 K
- Schutzrohr: Polycarbonat, 30mm Ø
- Abschlusskappen: ABS, schwarz
- Flexibler Lichthalterschlauch: 300mm (opt. 400 o. 500mm)
- Befestigung: Magnet, Anschraubplatte oder Schraubklemme
- Schutzart: IP54
- Schutzklasse: II bzw. III
- Zuleitung: 5m H05RN-F 2 x 1,00mm<sup>2</sup>
- Spannungsvarianten: 230V / 24V



## LED workplace lamp with flexible light holder tube.

- Illuminant: 6 POWER LEDs / 5000 K
- Protective tube: polycarbonate, 30mm Ø
- End caps: ABS, black
- Flexible light holder: 300mm (opt. 400 or 500mm)
- Fixation: magnet, mounting plate or screw clamp
- Protection category: IP54
- Protection class: II resp. III
- Cable: 5m H05RN-F 2 x 1,00mm<sup>2</sup>
- Voltage variants: 230V / 24V

### TECHNISCHE DATEN | TECHNICAL DATA

Nennspannung   <i>Nominal voltage</i>	220-240V AC	24V AC/DC
Strom   <i>Current</i>	0,035 A	0,21 A
Schutzklasse   <i>Protection class</i>	II	III
Anzahl LED   <i>Number LED</i>	6	6
Leistung   <i>Power</i>	5 W	6 W
Nutzlicht   <i>Real lumen</i>	430 Lm	530 Lm
Leuchte Energieeffizienzklasse <i>Luminaire energy efficiency class</i>		
Farbtemperatur   <i>Color temperature</i>	5000 K	
Farbwiedergabe   <i>Color rendering</i>	> 80	
Lebensdauer LED   <i>Lifetime LED</i>	> 50.000 h	
Umgebungstemp.   <i>Ambient temp.</i>	-20°C - +40°C	
IP Schutzart   <i>IP protection class</i>	IP54	
Diffusor   <i>Diffuser</i>	ja   yes	
Schutzrohr   <i>Protective tube</i>	Polycarbonat	
Abschlusskappen   <i>End caps</i>	ABS (Kunststoff   <i>plastic</i> )	
Zuleitung   <i>Cable</i>	5m H05RN-F 2 x 1,00mm <sup>2</sup>	
Stecker   <i>Plug</i>	230V Version: ja   yes (24V optional)	

### MIT MAGNET | WITH MAGNET

	Art-Nr. / 230V	Art-Nr. / 24V
KE-LED 3006-P/A-M / 300mm Lichthalter   <i>light holder</i>	131475	131494
KE-LED 3006-P/A-M / 400mm Lichthalter   <i>light holder</i>	131581	131584
KE-LED 3006-P/A-M / 500mm Lichthalter   <i>light holder</i>	131517	131580

### MIT ANSCHRAUBPLATTE | WITH MOUNTING PLATE

	Art-Nr. / 230V	Art-Nr. / 24V
KE-LED 3006-P/A-P / 300mm Lichthalter   <i>light holder</i>	131476	131526
KE-LED 3006-P/A-P / 400mm Lichthalter   <i>light holder</i>	131582	131585
KE-LED 3006-P/A-P / 500mm Lichthalter   <i>light holder</i>	131583	131577

### MIT SCHRAUBKLEMME | WITH SCREW CLAMP

	Art-Nr. / 230V	Art-Nr. / 24V
KE-LED 3006-P/A-K / 300mm Lichthalter   <i>light holder</i>	131477	131527
KE-LED 3006-P/A-K / 400mm Lichthalter   <i>light holder</i>	131537	131586
KE-LED 3006-P/A-K / 500mm Lichthalter   <i>light holder</i>	131538	131587

### ABMESSUNGEN | DIMENSIONS (IN MM)

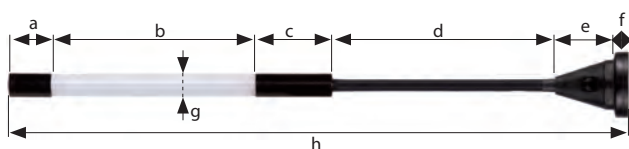

	a	b	c	d	e	f	g	h
mit 300mm Lichthalter   <i>light holder</i>	60	285	105	290	80	20	30	840
mit 400mm Lichthalter   <i>light holder</i>	60	285	105	390	80	20	30	940
mit 500mm Lichthalter   <i>light holder</i>	60	285	105	490	80	20	30	1040

Gewicht | *Weight*: ca. 1,5kg

# KE-LED 4010-P/A-.. | LED ARBEITSPLATZLEUCHE | LED WORKPLACE LAMP

## Merkmale | Features

10x  
POWER  
LED

230V  
110V  
42V  
24V

IP54

H05  
RN-F



Abschlussstopfen Hart-PVC  
*end plugs hard PVC*

10x POWER LEDs | 5000K  
10x POWER LEDs | 5000K

PMMA Schutzrohr  
*PMMA protective tube*

Diffusorfolie integriert  
*integrated diffuser film*

flexibler Lichthalterschlauch  
*flexible light-holder*

Ein-/Aus-Schalter  
*on/off-Switch*

verschiedene Befestigungsvarianten  
*different mounting options*

Zuleitung H05RN-F  
*cable H05RN-F*

Befestigungsvarianten  
*mounting options*



Magnet  
*magnet*



Anschraubplatte  
*mounting plate*



Schraubklemme  
*screw clamp*



## VORTEILE | ADVANTAGES

- flexibler Lichthalterschlauch zur optimalen Ausrichtung des Leuchtenkopfs
- blendfreies Licht dank Diffusorfolie
- verschiedene Befestigungsvarianten erhältlich
- *flexible light holder tube for optimal alignment of the lamp head*
- *glare-free light thanks integrated diffuser foil*
- *various mounting variants available*

## EINSATZBEREICHE | AREAS OF APPLICATION

- Werkbänke, Maschinen und Anlagen
- CNC- und Bohrmaschinen
- Laborarbeitsplätze
- *workbenches and machines*
- *CNC and drilling machines*
- *laboratory workstations*



# KE-LED 4010-P/A-.. | LED ARBEITSPLATZLEUCHE | LED WORKPLACE LAMP



## LED Arbeitsplatzleuchte mit flexiblem Lichthalterschlauch.

- Leuchtmittel: 10 POWER LEDs / 5000 K
- Schutzrohr: PMMA, 40mm Ø
- Abschlussteile: Hart-PVC, grau
- Flexibler Lichthalterschlauch: 300mm (opt. 400 o. 500mm)
- Befestigung: Magnet, Anschraubplatte oder Schraubklemme
- Schutzart: IP54
- Schutzklasse: II bzw. III
- Zuleitung: 5m H05RN-F 2 x 1,00mm<sup>2</sup>
- Spannungsvarianten: 230V / 24V (110V / 42V auf Anfrage)



## LED workplace lamp with flexible light holder tube.

- Illuminant: 10 POWER LEDs / 5000 K
- Protective tube: PMMA, 40mm Ø
- End plugs: Hard-PVC, grey
- Flexible light holder: 300mm (opt. 400 or 500mm)
- Fixation: magnet, mounting plate or screw clamp
- Protection category: IP54
- Protection class: II resp. III
- Cable: 5m H05RN-F 2 x 1,00mm<sup>2</sup>
- Voltage variants: 230V / 24V (110V / 42V on request)

### TECHNISCHE DATEN | TECHNICAL DATA

Nennspannung   Nominal voltage	220-240V AC	110V AC/DC	42V AC/DC	24V AC/DC
Strom   Current	0,04 A	0,085 A	0,165 A	0,32 A
Schutzklasse   Protection class	II	II	III	III
Anzahl LED   Number LED	10	10	10	10
Leistung   Power	6,7 W	6,5 W	8 W	8,5 W
Nutzlicht   Real lumen	670 Lm	700 Lm	800 Lm	820 Lm
Leuchte Energieeffizienzklasse Luminaire energy efficiency class				
Farbtemperatur   Color temperature	5000 K			
Farbwiedergabe   Color rendering	> 80			
Lebensdauer LED   Lifetime LED	> 50.000 h			
Umgebungstemp.   Ambient temp.	-20°C - +40°C			
IP Schutzart   IP protection class	IP65			
Diffusor   Diffuser	ja   yes			
Schutzrohr   Protective tube	PMMA			
Abschlussteile   End plugs	PVC			
Zuleitung   Cable	5m H05RN-F 2 x 1,00mm <sup>2</sup>			
Stecker   Plug	230V Version: ja   yes (110V / 42V / 24V optional)			

MIT MAGNET   WITH MAGNET	Art-Nr. / 230V	Art-Nr. / 110V	Art-Nr. / 42V	Art-Nr. / 24V
KE-LED 4010-P/A-M / 300mm Lichthalter   light holder	131388	131497	131487	131489
KE-LED 4010-P/A-M / 400mm Lichthalter   light holder	131457	131597	131486	131825
KE-LED 4010-P/A-M / 500mm Lichthalter   light holder	131531	131598	131599	131556
MIT ANSCHRAUBPLATTE   WITH MOUNTING PLATE	Art-Nr. / 230V	Art-Nr. / 110V	Art-Nr. / 42V	Art-Nr. / 24V
KE-LED 4010-P/A-P / 300mm Lichthalter   light holder	131363	131774	131513	131528
KE-LED 4010-P/A-P / 400mm Lichthalter   light holder	131569	131775	131777	131779
KE-LED 4010-P/A-P / 500mm Lichthalter   light holder	131479	131776	131778	131814
MIT SCHRAUBKLEMME   WITH SCREW CLAMP	Art-Nr. / 230V	Art-Nr. / 110V	Art-Nr. / 42V	Art-Nr. / 24V
KE-LED 4010-P/A-K / 300mm Lichthalter   light holder	131389	131819	131822	131529
KE-LED 4010-P/A-K / 400mm Lichthalter   light holder	131815	131820	131823	131817
KE-LED 4010-P/A-K / 500mm Lichthalter   light holder	131816	131821	131824	131818

### ABMESSUNGEN | DIMENSIONS (IN MM)

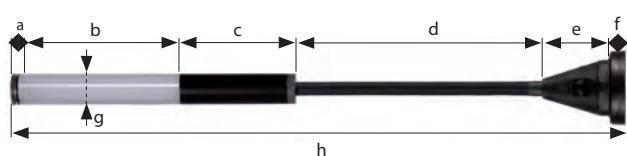

	a	b	c	d	e	f	g	h
mit 300mm Lichthalter   light holder	25	200	155	290	80	20	40	770
mit 400mm Lichthalter   light holder	25	200	155	390	80	20	40	870
mit 500mm Lichthalter   light holder	25	200	155	490	80	20	40	970

Gewicht | Weight: ca. 1,5kg

# E 27 | ARBEITSPLATZLEUCHE | WORKPLACE LAMP

## Merkmale | Features



passendes LED Leuchtmittel  
suitable LED lamp



Befestigungsvarianten  
mounting options



Magnet  
magnet



Anschraubplatte  
mounting plate



Schraubklemme  
screw clamp



## VORTEILE | ADVANTAGES

- flexibler Lichthalterschlauch zur optimalen Ausrichtung des Leuchtenkopfs
- verschiedene Befestigungsvarianten erhältlich
- flexible light holder tube for optimal alignment of the lamp head
- various mounting variants available

## EINSATZBEREICHE | AREAS OF APPLICATION

- Werkbänke, Maschinen und Anlagen
- CNC- und Bohrmaschinen
- workbenches and machines
- CNC and drilling machines

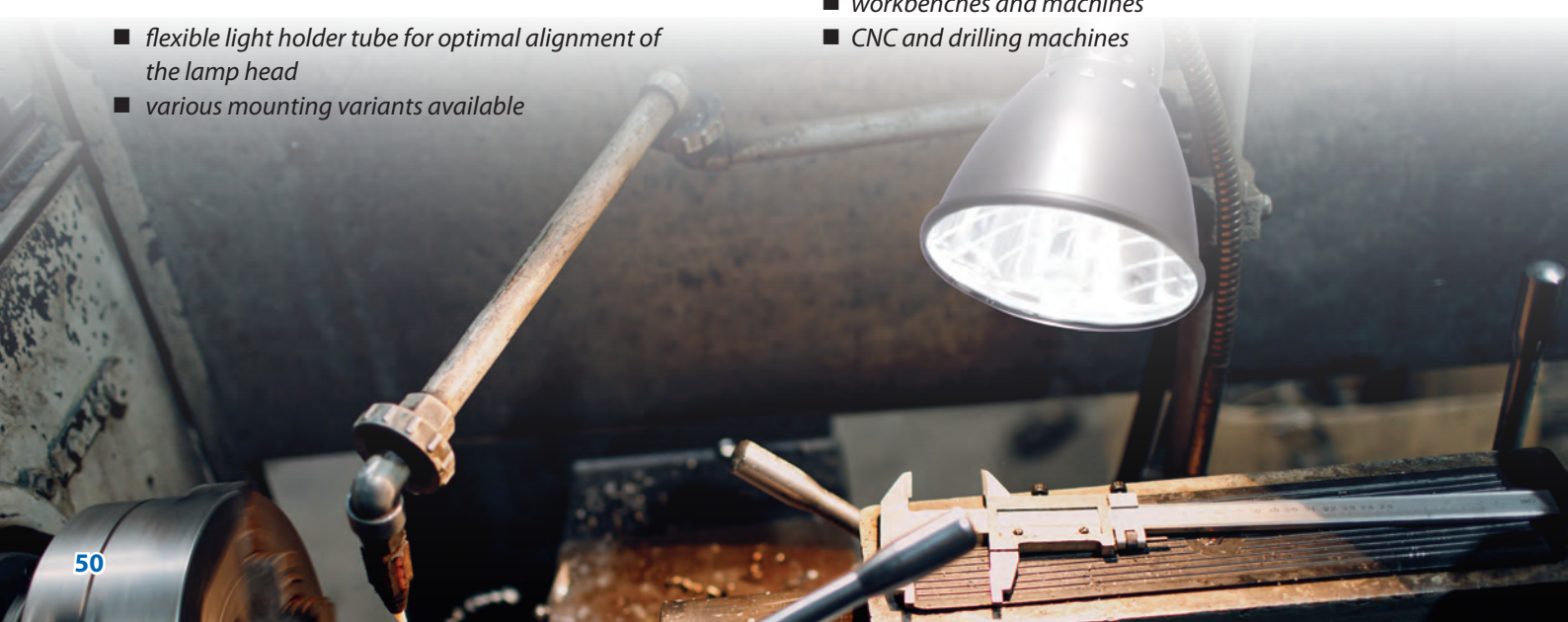

## E 27 | ARBEITSPLATZLEUCHE | WORKPLACE LAMP



### E27 Arbeitsplatzleuchte mit flexiblem Lichthalterschlauch.

- Reflektor: Aluminium, eloxiert, mit Schutzgitter
- optionales Leuchtmittel: E27 LED, 11 Watt, 1055 Lm
- Flexibler Lichthalterschlauch: 300mm (opt. 400 o. 500mm)
- Befestigung: Magnet, Anschraubplatte oder Schraubklemme
- Schutzart: IP20
- Schutzklasse: II
- Zuleitung: 5m H05RN-F 2 x 1,00mm<sup>2</sup>
- Spannungsvarianten: 230V (42V / 24V auf Anfrage)



### E27 workplace lamp with flexible light holder tube.

- Reflector: aluminium, anodized, with protective grid
- optional illuminant: E27 LED, 11 watts, 1055 Lm
- Flexible light holder: 300mm (opt. 400 or 500mm)
- Fixation: magnet, mounting plate or screw clamp
- Protection category: IP20
- Protection class: II
- Cable: 5m H05RN-F 2 x 1,00mm<sup>2</sup>
- Voltage variants: 230V (42V / 24V on request)

### TECHNISCHE DATEN | TECHNICAL DATA

Nennspannung   <i>Nominal voltage</i>	230V(optional 42V oder 24V)
Schutzklasse   <i>Protection class</i>	II
Leuchtmittel   <i>Illuminat</i>	optional erhältlich
IP Schutzart   <i>IP protection class</i>	IP20
Reflektor   <i>Reflector</i>	Aluminium eloxiert, mit Schutzgitter   <i>Aluminium anodized, with protective grid</i>
Lichthalter   <i>light holder</i>	300mm flexibel (optional 400mm / 500mm)
Ein-/Aus-Schalter   <i>On-/Off-Switch</i>	im Sockel integriert   <i>integrated in the base</i>
Befestigung   <i>Fixation</i>	Magnet / Platte / Klemme   <i>magnet / mounting plate / screw clamp</i>
Zuleitung   <i>Cable</i>	5m H05RN-F 2 x 1,00mm <sup>2</sup>
Stecker   <i>Plug</i>	230V Version: ja   <i>yes</i>

	Art-Nr.   Art-No mit Magnet   <i>with magnet</i>	Art-Nr.   Art-No mit Platte   <i>with plate</i>	Art-Nr.   Art-No mit Klemme   <i>with clamp</i>
E 27-230V / 300mm Lichthalter   <i>light holder</i>	141327	141727	141827
E 27-230V / 400mm Lichthalter   <i>light holder</i>	141427	141726	141826
E 27-230V / 500mm Lichthalter   <i>light holder</i>	141527	141529	141526

### OPTIONAL LEUCHTMITTEL | OPTIONAL ILLUMINAT

	Art-Nr.   Art-No
E27 LED - 1055 Lumen - 11 Watt	200400

### ABMESSUNGEN | DIMENSIONS (IN MM)

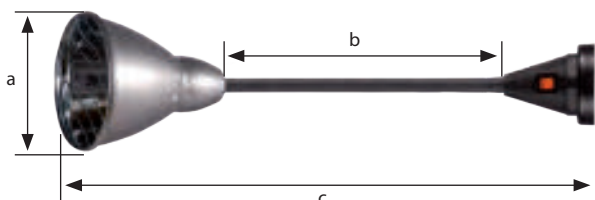

	a	b	c
mit 300mm Lichthalter   <i>light holder</i>	135	300	550
mit 400mm Lichthalter   <i>light holder</i>	135	400	650
mit 500mm Lichthalter   <i>light holder</i>	135	500	750
Gewicht   <i>Weight</i> : ca. 1,8kg			

# 3010 / 5018 | UVA LED LEUCHTEN | UVA LED LAMPS

## Merkmale | Features



Metallhaken, drehbar  
metall hook, rotatable

18x UV-A LEDs | 365nm  
18x UV-A LEDs | 365nm

Plexiglas, 50mm Ø  
Plexiglas, 50mm Ø

10x UV-A LEDs | 365nm  
10x UV-A LEDs | 365nm

Plexiglas, 30mm Ø  
Plexiglas, 30mm Ø

PVC Handgriff  
PVC handle

Endkappen ABS  
End caps ABS

KE-LED 5018 UV-A

KE-LED 3010 UV-A



KE-LED-EA 3010 UV-A

## VORTEILE | ADVANTAGES

- mobil und flexibel einsetzbar
- langlebig
- mobile and flexible to use
- durable

## EINSATZBEREICHE | AREAS OF APPLICATION

- Forensik, Tatortuntersuchungen
- Geldprüfung, Banknotenprüfung
- Dokumentenprüfung
- Beschichtungsprüfungen
- Leckageerkennung
- Schädlingsbekämpfung
- forensics, crime scene investigations
- money check, banknote check
- document verification
- coating tests
- leak detection
- pest control workshops

# 3010 / 5018 | UVA LED LEUCHTEN | UVA LED LAMPS



**UVA LED-Leuchten, flexibel einsetzbar für Spezialanwendungen wie Forensik, Schädlingsbekämpfung, Aushärtung etc.**

- Leuchtmittel: 10x bzw. 18x UV-A LEDs / 365nm
- Schutzrohr: Plexiglas, 30mm Ø bzw. 50mm Ø
- Handgriff: PVC (Handleuchten Ausführung)
- Endkappen: ABS (Rohrleuchtenausführung)
- Schutzart: IP54
- Schutzklasse: II / III
- Zuleitung: 5m H05RN-F 2 x 1,00mm<sup>2</sup> mit Stecker
- Spannungsvarianten: 230V (optional 24V)
- Längere Zuleitung, Kabeltyp, Stecker etc. auf Anfrage



**UVA LED lamps, can be used flexibly for special applications such as forensics, pest control, curing, etc.**

- Illuminant: 10x or 18x UV-A LEDs / 365nm
- Protective tube: Plexiglas, 30mm Ø or 50mm Ø
- Handle: PVC (hand lamp version)
- End caps: ABS (tub luminaire version)
- Protection class: IP54
- Protection class: II / III
- Supply cable: 5m H05RN-F 2 x 1.00mm<sup>2</sup> with plug
- Voltage variants: 230V (optional 24V)
- Longer supply line, cable type, plug etc. on request

## TECHNISCHE DATEN | TECHNICAL DATA

Modell   Model	KE-LED-EA 3010 UV-A	KE-LED 3010 UV-A	KE-LED 5018 UV-A
Version   Version	Rohrleuchte	Handleuchte	Handleuchte
Art.-Nr.   Art.-No.	106012	106007	106009
Nennspannung   Nominal voltage	230V AC	230V AC	230V AC
Schutzklasse   Protection class	II	II	II
Anzahl LED   Number LED	10	10	18
Wellenlänge   Wavelength	365nm	365nm	365nm
Handgriff   Wavelength	ABS Endkappen / ABS end caps	PVC	PVC
Befestigung   Fastening	2x Klammer / 2x clamp	---	---
Ein-Aus Schalter   On-Off Switch	ja / yes	nein / no	nein / no
Lebensdauer LED   Lifetime LED	> 50.000 h		
Umgebungstemp.   Ambient temp.	-20°C - +40°C		
IP Schutzart   IP protection class	IP54		
Schutzrohr   Protective tube	Plexiglas		
Zuleitung   Cable	5m H05RN-F 2 x 1,00mm <sup>2</sup>		
Stecker   Plug	230V Version: ja   yes (24V optional)		

## ABMESSUNGEN | DIMENSIONS (IN MM)

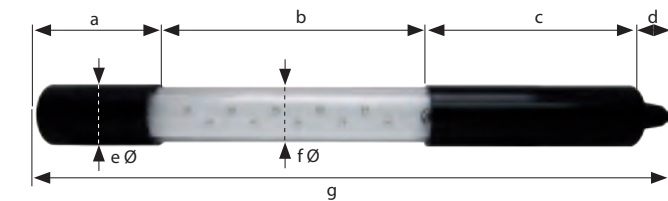

a	b	c	d	e	f	g
45	55	135	115	40	45	30

Gewicht | Weight: ca. 0,5kg

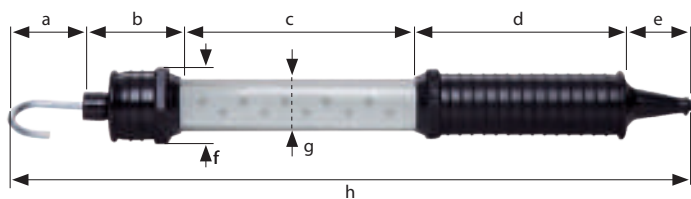

a	b	c	d	e	f	g	h
45	55	125	115	40	45	30	390

Gewicht | Weight: ca. 0,5kg

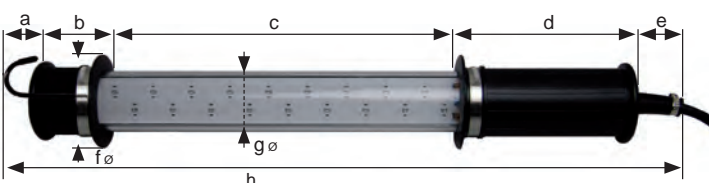

a	b	c	d	e	f	g	h
30	50	280	130	40	75	50	530

Gewicht | Weight: ca. 0,8kg

# LEUCHTEN KOMPLETT-SET | LUMINAIRE COMPLETE-SET

## Merkmale | Features

LED 360° 3x 6200 Lumen 230V

### TRIO 5045-STA



## SET BEINHALTET | SET INCLUDES

Art.-Nr.   Art.-No.	117011
LED Leuchte 360°   LED lamp 360°	3x KE-LED 5045-M 6200 Lm / 4100K / 230V / 10m H07RN-F
Standfuß   Metal stand	1x STA-50 Metall-Standfuß Metal stand
(Preis auf Anfrage   price on request)	

## Merkmale | Features

LED 4x 3000 Lumen 230V

### HB-4030

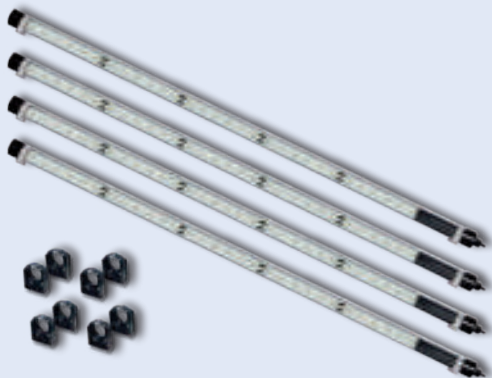

## SET BEINHALTET | SET INCLUDES

Art.-Nr.   Art.-No.	131614
LED Leuchte   LED lamp	4x KE-LED-EA 4030 3000 Lm / 5000K / 230V / 5m H05RN-F
Befestigung   Fixation	8x BFK-D40 Befestigungsklam- mern Mounting brackets
(Preis auf Anfrage   price on request)	

## Merkmale | Features

LED 2x 820 Lumen 2x 530 Lumen 24V

### LED 10-06 TRA



## SET BEINHALTET | SET INCLUDES

Art.-Nr.   Art.-No.	131736
LED Leuchte   LED lamp	2x KE-LED 4010 820 Lm / 5000K / 230V / 5m H05RN-F / CEE 24V
LED Leuchte   LED lamp	2x KE-LED 3006 530 Lm / 5000K / 230V / 5m H05RN-F / CEE 24V
Trafo   Transformer	250/4-24 250VA / 230-24V 4x CEE
(Preis auf Anfrage   price on request)	

# LED Akku-Leuchten - Einsatzgebiete

## LED rechargeable lamps - areas of application



# LED AKKU HANDSCHEINWERFER | LED RECHARGEABLE HAND LAMP

## Merkmale | Features



SL 5 LED

SL 6 LED

SL 7 LED

SL 8 LED

alle Modelle mit  
Notstromfunktion  
*all models with  
emergency function*



schwenkbarer  
Leuchtenkopf  
*swiveling  
lamp head*

Standard Blei-Gel - Akku  
*standard lead gel - battery*

hochwertiger LiFePO4 - Akku  
*high quality LiFePO4 - battery*

SL 5 & SL 7 - ohne Linsenfokus  
breite Ausleuchtung  
*SL 5 & SL 7 - without lens focus  
wide illumination*

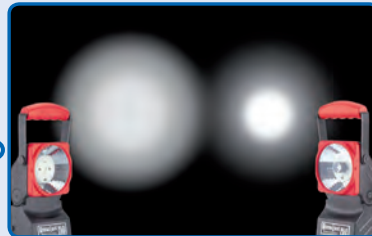

SL 6 & SL 8 - mit Linsenfokus  
hohe Leuchtweite  
*SL 6 & SL 8 - with lens focus  
high light range*



## VORTEILE | ADVANTAGES

- wahlweise mit oder ohne Fokus-Linse
- LiFePO4 Akku bis zu 4x langlebiger als Standard-Akku
- Notstromfunktion
- *optionally with or without focus lens*
- *LiFePO4 battery up to 4x longer lasting than standard battery*
- *emergency power function*

## EINSATZBEREICHE | AREAS OF APPLICATION

- Rettungswesen & Katastrophenschutz
- Verkehrsbetriebe
- Sicherheitsdienste
- *rescue and disaster control*
- *transport services*
- *security services*





# LED AKKU HANDSCHEINWERFER | LED RECHARGEABLE HAND LAMP



**LED Arbeits- und Notstromleuchte mit leistungsstarkem Akku. Im Set mit Ladestation, Vorsatzscheibe "orange", Netzkabel 230V und Kabel mit KFZ-Netzstecker 12/24V.**

- LED Handscheinwerfer: wiederaufladbar
- SL 5 & SL 7 LED: breite, gleichmässige Ausleuchtung
- SL 6 & SL 8 LED: mit Fokus-Linse für hohe Leuchtweite
- Gehäuse: Kunststoff
- Schutzart: IP54
- SL 5 & SL 6 Akku: wartungsfreier Blei-Gel-Akku
- SL 7 & SL 8 Akku: Lithium-Eisenphosphat-Akku (LiFePO4) sehr geringe Selbstentladung, bis zu 4 mal langlebiger als herkömmliche Akkus!
- Notstromfunktion: schaltet sich bei Stromausfall ein
- Ladeinheit: Ladestation für Wandmontage geeignet



**LED working- and emergency power lamp mit rechargeable battery. In a set with charging station, front cover lense "orange", cable 230V and car power plug 12/24V.**

- LED hand lamp: rechargeable
- SL 5 & SL 7 LED: wide, homogeneous illumination
- SL 6 & SL 8 LED: focus lense for wide headlight range
- Housing: plastic
- Protection category: IP54
- SL 5 & SL 6 battery: low-maintenance lead-gel accu
- SL 7 & SL 8 battery: the Lithium-Iron Phosphate battery (LiFePO4) has a very low discharge factor: therefore the longevity is 4 times higher than of common batteries
- Emergency function: in case of electrical power outage
- Charging unit: charging station suitable for wall mounting

## TECHNISCHE DATEN | TECHNICAL DATA

Typ   Type	SL 5 LED Set	SL 6 LED Set	SL 7 LED Set	SL 8 LED Set
Art.-Nr.   Art.-No.	290850	290820	290862	290863
Fokus Linse   Focus lens	nein   no	ja   yes	nein   no	ja   yes
Leuchtweite   Headlight range	ca. 150m	ca. 170m	ca. 150m	ca. 170m
Hauptlampe   Main lamp	POWER LED		POWER LED	
Leuchtdauer   Duration	ca. 5h		ca. 5h	
Pilotlampe   Pilot lamp	Nichia LED 5mm		Nichia LED 5mm	
Leuchtdauer   Duration	ca. 75h		ca. 165h	
IP Schutzart   IP protection	IP54		IP54	
Accu   Battery	Blei-Gel   lead gel - 4V/3,5Ah		Lithium-Eisenphosphat   lithium-iron-phosphate	
Ladespannung   Charging volt.	230V AC 50/60Hz, 12/24V DC		230V AC 50/60Hz, 12/24V DC	
Gehäuse   Housing	Kunststoff, schlagzäh   plastic impact resistant		Kunststoff, schlagzäh   plastic impact resistant	
Maße/Gewicht   Dimen./Weight	104mm x 245mm x 72mm / 1,1 kg		104mm x 245mm x 72mm / 1,1 kg	

## ABMESSUNGEN | DIMENSIONS (IN MM)

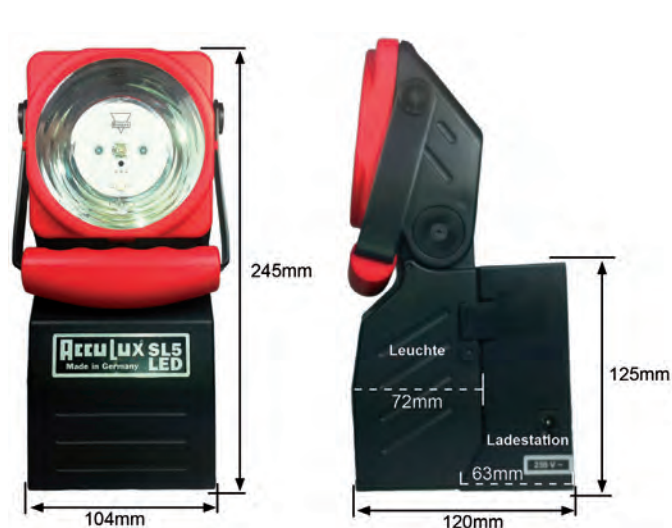

	Breite Width	Höhe Height	Tiefe Depth
SL LED Leuchte   lamp	104	245	72
Ladestation   charging unit	104	125	63
Komplett   complete	104	245	120

im Lieferumfang enthalten  
included in the scope of delivery



- Ladestation | charging unit
- Vorsatzscheibe "orange" | front lense "orange"
- Ladekabel 230V | charging cable 230V
- Ladekabel 12/24V | charging cable 12/24V

# LED AKKU HANDLEUCHTEN | LED RECHARGEABLE HAND LAMPS

## Merkmale | Features

LED 270 Lumen IP20 230V 24V 12V AUFLADBAR

### UniLux Pro LED

2 Schaltstufen: 100% & 20%  
2 switching levels: 100% & 20%



Linsenoptik fokussierbar  
lens optics focusable

inklusive | included



## TECHNISCHE DATEN | TECHNICAL DATA

Art.-Nr.   Art.-No.	290864
Hauptlampe   Main lamp	POWER LED
Leuchtweite   Headlight range	ca. 1000m
Lumen   Lumen	270 Lm
Leuchtdauer   Duration	ca. 6h 100% / 35h 20%
IP Schutzart   IP protection	IP20
Accu   Battery	Li-Io 3,7V / 4400mAh
Gewicht   Weight	400gr
Ladespannung   Charging volt.	100-240V/ 12/24V / USB
Gehäuse   Housing	Kunststoff   plastic

## Merkmale | Features

LED 1500 Lumen IP54 230V 24V 12V AUFLADBAR

### 1500 LED

zusammenklappbar  
collapsible



Magnethalterung  
magnetic mount



## TECHNISCHE DATEN | TECHNICAL DATA

Art.-Nr.   Art.-No.	290661
Hauptlampe   Main lamp	POWER LED
Lumen   Lumen	ca. 1500 Lm
Leuchtdauer   Duration	2,5h / 5h / 10h
Ladezeit   Load time	ca. 6h
IP Schutzart   IP protection	IP54
Accu   Battery	Li-Ionen
Gewicht   Weight	820gr
Ladespannung   Charging volt.	230V/ 12/24V
Gehäuse   Housing	Kunststoff   plastic

## Merkmale | Features

LED 500 Lumen IP54 230V 24V 12V AUFLADBAR

### IL 500 LED

Kopf- & Seitenlicht  
head and side light



Powerbank-Funktion  
powerbank function

Standfuss mit Magnethalterung  
stand with magnetic holder



## TECHNISCHE DATEN | TECHNICAL DATA

Art.-Nr.   Art.-No.	290865
Nahbereich   Close range	max. 500 Lm / 3h
Fernbereich   Far range	max. 170 Lm / 4h
Helligkeit   Brightness	dimmbar   dimmable
Rortlicht   Red light	ja   yes
IP Schutzart   IP protection	IP54
Accu   Battery	Li-Io 3,7V / 2200mAh
Gewicht   Weight	200gr
Aufladbar   Rechargeable	über USB   via USB
Gehäuse   Housing	Kunststoff   plastic

# KIRA ATEX Handleuchten - Einsatzgebiete

## KIRA ATEX hand lamps - areas of application



# KE-LED-EX 4003-P | ATEX LED HANDLEUCHTE | ATEX LED HAND LAMP

## Merkmale | Features

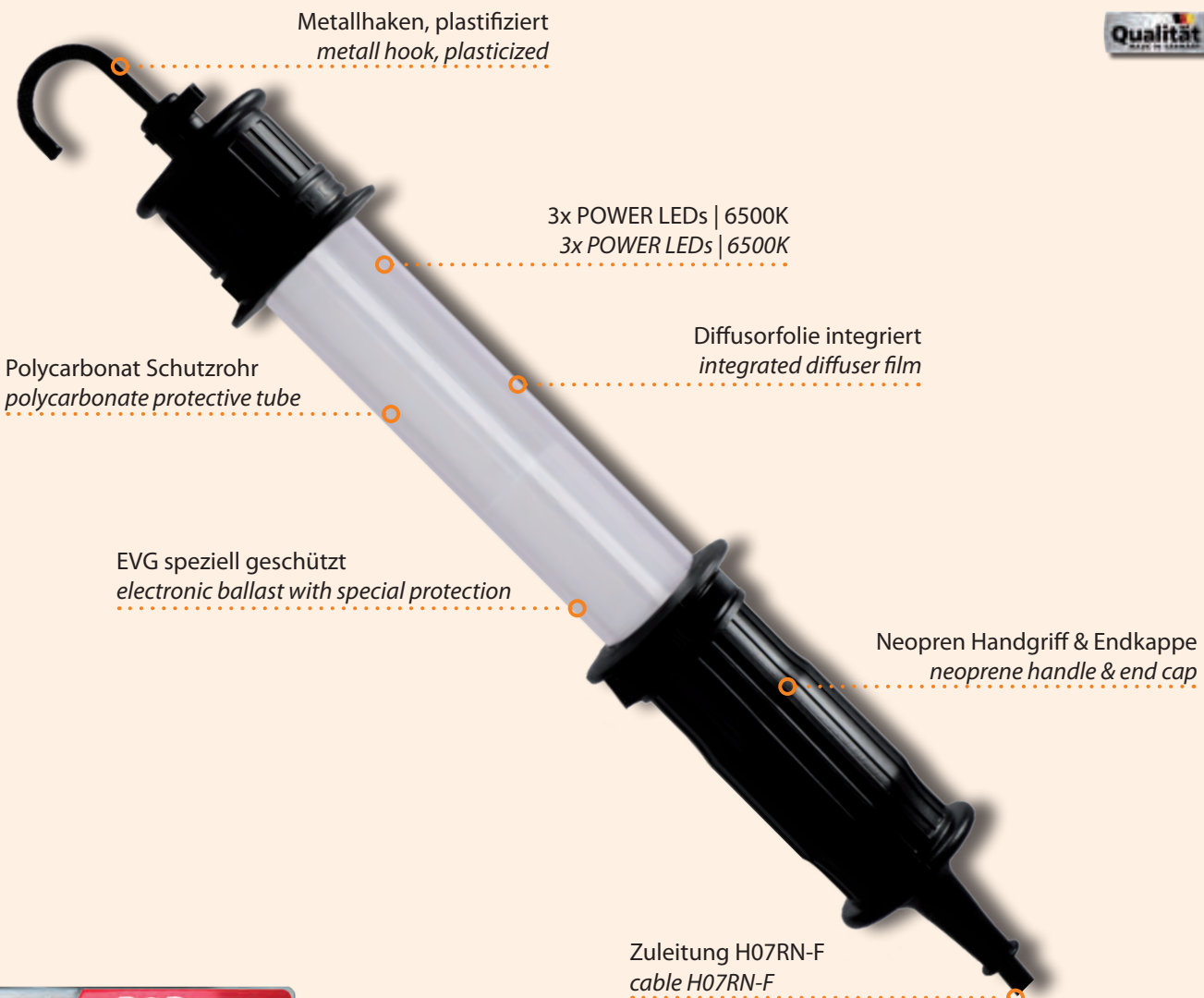

Metallhaken, plastifiziert  
*metall hook, plasticized*

3x POWER LEDs | 6500K  
3x POWER LEDs | 6500K

Diffusorfolie integriert  
*integrated diffuser film*

Polycarbonat Schutzrohr  
*polycarbonate protective tube*

EVG speziell geschützt  
*electronic ballast with special protection*

Neopren Handgriff & Endkappe  
*neoprene handle & end cap*

Zuleitung H07RN-F  
*cablе H07RN-F*



## Vorteile | Advantages

- kompakt und leicht
- robustes, schlagfestes Polycarbonatrohr
- homogenes und blendfreies Licht
- *compact and light*
- *robust, impact-resistant polycarbonate tube*
- *homogeneous and glare-free light*

## Einsatzbereiche | Areas of application

- Inspektions- & Servicearbeiten im EX-Bereich
- Flugzeugwartung
- Chemische Industrie
- *inspection and service work in EX areas*
- *aircraft maintenance*
- *chemical industry*



# KE-LED-EX 4003-P | ATEX LED HANDLEUCHTE | ATEX LED HAND LAMP



**Kompakte und leichte ATEX Handleuchte. Ideal zur Ausleuchtung von beengten Bereichen.**

- Leuchtmittel: 3 POWER LEDs / 6500K
- Schutzrohr: Polycarbonat, schlagfest, 40mm Ø
- Handgriff / Abschlusskappe: Neopren, schwarz
- Metallhaken: ja, drehbar, plastifiziert
- Schutzart: IP68-50m / 5h
- Schutzklasse: II bzw. III
- Zuleitung: 10m H07RN-F 2 x 1,00mm<sup>2</sup>
- Spannungsvarianten: 230V / 110V / 42V / 24V / 12V



**Compact and lightweight ATEX hand lamp. Ideal for illuminating difficult to access areas.**

- Illuminant: 3 POWER LEDs / 6500K
- Protective tube: polycarbonate, 40mm Ø
- Handle / end cap: neoprene, black
- Metal hook: yes, rotatable, plasticized
- Protection category: IP68-50m / 5h
- Protection class: II resp. III
- Cable: 10m H07RN-F 2 x 1,00mm<sup>2</sup>
- Voltage variants: 230V / 110V / 42V / 24V / 12V

## TECHNISCHE DATEN | TECHNICAL DATA

Art.-Nr.   Art.-No.	147000	147010	147020	147030	147040
Nennspannung   Nominal voltage	220-240V AC	110V AC/DC	42V AC/DC	24V AC/DC	12V AC/DC
Strom   Current	0,03 A	0,025 A	0,075 A	0,10 A	0,20 A
Schutzklasse   Protection class	II	II	II	III	III
Anzahl LED   Number LED	3	3	3	3	3
Leistung   Power	3,3 W	3,0 W	3,8 W	3,0 W	2,8 W
Nutzlicht   Real lumen	200 Lm	185 Lm	180 Lm	255 Lm	235 Lm
Leuchte Energieeffizienzklasse Luminaire energy efficiency class					
Farbtemperatur   Color temperature	6500 K				
Farbwiedergabe   Color rendering	> 70				
Lebensdauer LED   Lifetime LED	> 50.000 h				
Umgebungstemp.   Ambient temp.	-20°C - +50°C				
IP Schutzart   IP protection class	IP68-50m / 5h				
Diffusor   Diffuser	ja   yes				
Schutzrohr   Protective tube	Polycarbonat / IK10				
Handgriff / Kappe   Handle / End cap	Neopren				
Zuleitung   Cable	10m H07RN-F 2 x 1,00mm <sup>2</sup>				
Stecker   Plug	optional				
Gas   Gas	Ex eb mb op is IIC T4 Gb				
Staub   Dust	Ex tb op is IIIC T105°C Db				
Kategorie   Category	2 G / 2 D				
Zonen   Zones	Zone 1, 2 / 21, 22				
Temperaturklasse   Temperature class	T4 +T105°C				
Prüfzertifikat   Test certificate	TÜV 18 ATEX 8184				

## ABMESSUNGEN | DIMENSIONS (IN MM)

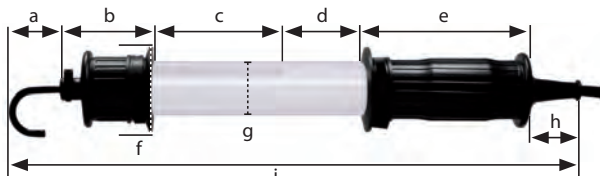

a	b	c	d	e	f	g	h	i
40	65	100	70	115	43	40	40	430

Gewicht | Weight: ca. 1,55kg

## ZUBEHÖR | ACCESSORIES



# KE-LED-EX 4006-O | ATEX LED HANDLEUCHTE | ATEX LED HAND LAMP

## Merkmale | Features



6x  
POWER  
LED

230V  
110V  
42V  
24V  
12V

IP68

H07  
RN-F

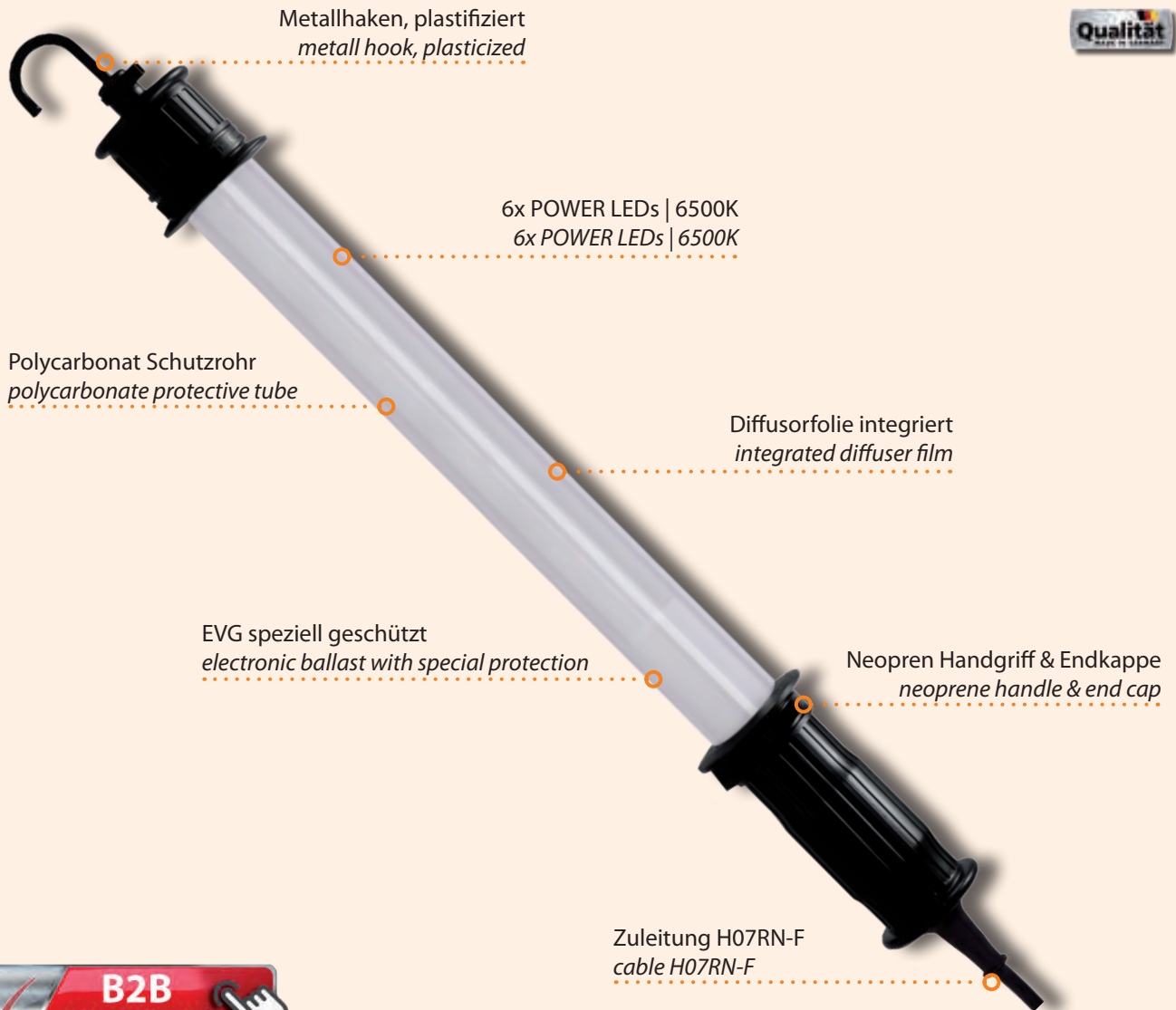

Metallhaken, plastifiziert  
*metall hook, plasticized*

6x POWER LEDs | 6500K  
*6x POWER LEDs | 6500K*

Polycarbonat Schutzrohr  
*polycarbonate protective tube*

Diffusorfolie integriert  
*integrated diffuser film*

EVG speziell geschützt  
*electronic ballast with special protection*

Neopren Handgriff & Endkappe  
*neoprene handle & end cap*

Zuleitung H07RN-F  
*cable H07RN-F*



## VORTEILE | ADVANTAGES

- geringes Leuchtengewicht
- robustes, schlagfestes Polycarbonatrohr
- homogenes und blendfreies Licht
- *light weight of the lamp*
- *robust, impact-resistant polycarbonate tube*
- *homogeneous and glare-free light*

## EINSATZBEREICHE | AREAS OF APPLICATION

- Inspektions- & Servicearbeiten im EX-Bereich
- Flugzeugwartung
- Chemische Industrie
- Mühlen & Biogasanlagen
- *inspection and service work in EX areas*
- *aircraft maintenance*
- *chemical industry*
- *mills & biogas plants*



# KE-LED-EX 4006-O | ATEX LED HANDLEUCHE | ATEX LED HAND LAMP



**ATEX LED Handleuchte. Ideal für Wartungs- und Inspektionsarbeiten.**

- Leuchtmittel: 6 POWER LEDs / 6500K
- Schutzrohr: Polycarbonat, schlagfest, 40mm Ø
- Handgriff / Abschlusskappe: Neopren, schwarz
- Metallhaken: ja, drehbar, plastifiziert
- Schutzart: IP68-50m / 5h
- Schutzklasse: II bzw. III
- Zuleitung: 10m H07RN-F 2 x 1,00mm<sup>2</sup>
- Spannungsvarianten: 230V / 110V / 42V / 24V / 12V



**ATEX LED hand lamp, ideal for service- and inspection work.**

- Illuminant: 6 POWER LEDs / 6500K
- Protective tube: polycarbonate, 40mm Ø
- Handle / end cap: neoprene, black
- Metal hook: yes, rotatable, plasticized
- Protection category: IP68-50m / 5h
- Protection class: II resp. III
- Cable: 10m H07RN-F 2 x 1,00mm<sup>2</sup>
- Voltage variants: 230V / 110V / 42V / 24V / 12V

## TECHNISCHE DATEN | TECHNICAL DATA

Art.-Nr.   Art.-No.	146000	146010	146020	146030	146040
Nennspannung   Nominal voltage	220-240V AC	110V AC/DC	42V AC/DC	24V AC/DC	12V AC/DC
Strom   Current	0,05 A	0,05 A	0,11 A	0,18 A	0,29 A
Schutzklasse   Protection class	II	II	II	III	III
Anzahl LED   Number LED	6	6	6	6	6
Leistung   Power	7 W	6,4 W	5,5 W	5,3 W	4,2 W
Nutzlicht   Real lumen	520 Lm	460 Lm	400 Lm	520 Lm	370 Lm
Leuchte Energieeffizienzklasse Luminaire energy efficiency class					
Farbtemperatur   Color temperature	6500 K				
Farbwiedergabe   Color rendering	> 70				
Lebensdauer LED   Lifetime LED	> 50.000 h				
Umgebungstemp.   Ambient temp.	-20°C - +50°C				
IP Schutzart   IP protection class	IP68-50m / 5h				
Diffusor   Diffuser	ja   yes				
Schutzrohr   Protective tube	Polycarbonat / IK10				
Handgriff / Kappe   Handle / End cap	Neopren				
Zuleitung   Cable	10m H07RN-F 2 x 1,00mm <sup>2</sup>				
Stecker   Plug	optional				
Gas   Gas	Ex eb mb op is IIC T4 Gb				
Staub   Dust	Ex tb op is IIIC T105°C Db				
Kategorie   Category	2 G / 2 D				
Zonen   Zones	Zone 1, 2 / 21, 22				
Temperaturklasse   Temperature class	T4 +T105°C				
Prüfzertifikat   Test certificate	TÜV 18 ATEX 8184				

## ABMESSUNGEN | DIMENSIONS (IN MM)

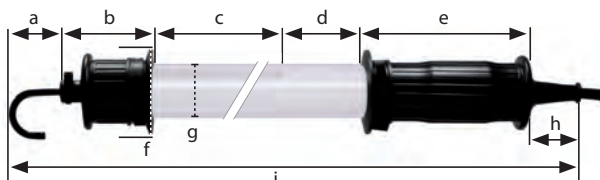

a	b	c	d	e	f	g	h	i
40	65	255	85	115	43	40	40	600

Gewicht | Weight: ca. 1,65kg

## ZUBEHÖR | ACCESSORIES



# KE-LED-EX 5018 | ATEX LED HANDLEUCHTE | ATEX LED HAND LAMP

## Merkmale | Features



Metallhaken, plastifiziert  
metall hook, plasticized

18x POWER LEDs | 6500K  
18x POWER LEDs | 6500K

Polycarbonat Schutzrohr  
polycarbonate protective tube

Diffusorfolie integriert  
integrated diffuser film

EVG speziell geschützt  
electronic ballast with special protection

Neopren Handgriff & Endkappe  
neoprene handle & end cap

Zuleitung H07RN-F  
cable H07RN-F



## VORTEILE | ADVANTAGES

- 360° Ausleuchtung
- leicht und handlich
- homogenes und blendfreies Licht
- 360° illumination
- light and handy
- homogeneous and glare-free light

## EINSATZBEREICHE | AREAS OF APPLICATION

- Reinigungs- & Servicearbeiten im EX-Bereich
- Tank-, Behälter- und Siloreinigung
- Kläranlagen / Kanalinspektion
- cleaning and service work in EX areas
- tank, container and silo cleaning
- sewage treatment plants / sewer inspection





# KE-LED-EX 5018 | ATEX LED HANDLEUCHTE | ATEX LED HAND LAMP



## ATEX LED Handleuchte mit 360° Ausleuchtung.

- Leuchtmittel: 18 POWER LEDs / 6500K
- Schutzrohr: Polycarbonat, schlagfest, 50mm Ø
- Handgriff / Abschlusskappe: Neopren, schwarz
- Metallhaken: ja, drehbar, plastifiziert
- Schutzart: IP68-50m / 5h
- Schutzklasse: III
- Zuleitung: 10m H07RN-F 2 x 1,00mm<sup>2</sup>
- Spannungsvariante: 24V



## ATEX LED hand lamp with 360° illumination.

- Illuminant: 18 POWER LEDs / 6500K
- Protective tube: polycarbonate, 50mm Ø
- Handle / end cap: neoprene, black
- Metal hook: yes, rotatable, plasticized
- Protection category: IP68-50m / 5h
- Protection class: III
- Cable: 10m H07RN-F 2 x 1,00mm<sup>2</sup>
- Voltage variant: 24V

### TECHNISCHE DATEN | TECHNICAL DATA

<b>Art.-Nr.   Art.-No.</b>	<b>149030</b>
Nennspannung   Nominal voltage	24V AC/DC
Strom   Current	0,33 A
Schutzklasse   Protection class	III
Anzahl LED   Number LED	18
Leistung   Power	10 W
Nutzlicht   Real lumen	1000 Lm
Leuchte Energieeffizienzklasse Luminaire energy efficiency class	<b>A</b> <b>F</b>
Farbtemperatur   Color temperature	6500 K
Farbwiedergabe   Color rendering	> 70
Lebensdauer LED   Lifetime LED	> 50.000 h
Umgebungstemp.   Ambient temp.	-20°C - +50°C
IP Schutzart   IP protection class	IP68-50m / 5h
Diffusor   Diffuser	ja   yes
Schutzrohr   Protective tube	Polycarbonat / IK10
Handgriff / Kappe   Handle / End cap	Neopren
Zuleitung   Cable	10m H07RN-F 2 x 1,00mm <sup>2</sup>
Stecker   Plug	optional
Gas   Gas	Ex eb mb op is IIC T4 Gb
Staub   Dust	Ex tb op is IIIC T105°C Db
Kategorie   Category	2 G / 2 D
Zonen   Zones	Zone 1, 2 / 21, 22
Temperaturklasse   Temperature class	T4 +T105°C
Prüfzertifikat   Test certificate	TÜV 18 ATEX 8191 X

### ABMESSUNGEN | DIMENSIONS (IN MM)

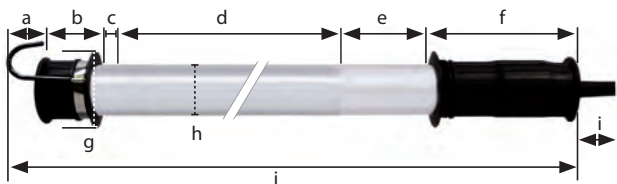

a	b	c	d	e	f	g	h	i	j
25	55	35	225	120	140	75	50	45	600

Gewicht | Weight: ca. 1,5kg

### ZUBEHÖR | ACCESSORIES



# KE-LED-EX 5024 | ATEX LED HANDLEUCHTE | ATEX LED HAND LAMP

## Merkmale | Features



Metallhaken, plastifiziert  
*metall hook, plasticized*

24x POWER LEDs | 6500K  
*24x POWER LEDs | 6500K*

Polycarbonat Schutzrohr  
*polycarbonate protective tube*

Diffusorfolie integriert  
*integrated diffuser film*

EVG speziell geschützt  
*electronic ballast with special protection*

Neopren Handgriff & Endkappe  
*neoprene handle & end cap*

Zuleitung H07RN-F  
*cable H07RN-F*



## VORTEILE | ADVANTAGES

- enorm hell und lichtstark
- schlanke Bauform und geringes Gewicht
- robustes, schlagfestes Polycarbonatrohr
- *enormously bright and powerful*
- *slim design and low weight*
- *robust, impact-resistant polycarbonate tube*

## EINSATZBEREICHE | AREAS OF APPLICATION

- Inspektions- & Servicearbeiten im EX-Bereich
- Ölindustrie & Chemische Industrie
- Mühlen & Biogasanlagen
- *inspection and service work in EX areas*
- *aircraft maintenance*
- *chemical industry*
- *mills & biogas plants*



# KE-LED-EX 5024 | ATEX LED HANDLEUCHTE | ATEX LED HAND LAMP



## Lichtstarke ATEX LED Handleuchte mit extrem helle und blendfreiem Licht.

- Leuchtmittel: 24 POWER LEDs / 6500K
- Schutzrohr: Polycarbonat, schlagfest, 50mm Ø
- Handgriff / Abschlusskappe: Neopren, schwarz
- Metallhaken: ja, drehbar, plastifiziert
- Schutzart: IP68-50m / 5h
- Schutzklasse: II bzw. III
- Zuleitung: 10m H07RN-F 2 x 1,00mm<sup>2</sup>
- Spannungsvarianten: 230V / 110V / 24V



## Powerful ATEX LED hand lamp with extremely bright and glare-free light.

- Illuminant: 24 POWER LEDs / 6500K
- Protective tube: polycarbonate, 50mm Ø
- Handle / end cap: neoprene, black
- Metal hook: yes, rotatable, plasticized
- Protection category: IP68-50m / 5h
- Protection class: II resp. III
- Cable: 10m H07RN-F 2 x 1,00mm<sup>2</sup>
- Voltage variants: 230V / 110V / 24V

### TECHNISCHE DATEN | TECHNICAL DATA

Art.-Nr.   Art.-No.	148000	148010	148030
Nennspannung   Nominal voltage	220-240V AC	110V AC/DC	24V AC/DC
Strom   Current	0,075 A	0,135 A	0,550 A
Schutzklasse   Protection class	II	II	III
Anzahl LED   Number LED	24	24	24
Leistung   Power	14,5 W	14,5 W	15,5 W
Nutzlicht   Real lumen	1550 Lm	1600 Lm	1650 Lm
Leuchte Energieeffizienzklasse Luminaire energy efficiency class			
Farbtemperatur   Color temperature		6500 K	
Farbwiedergabe   Color rendering		> 70	
Lebensdauer LED   Lifetime LED		> 50.000 h	
Umgebungstemp.   Ambient temp.		-20°C - +50°C	
IP Schutzart   IP protection class		IP68-50m / 5h	
Diffusor   Diffuser		ja   yes	
Schutzrohr   Protective tube		Polycarbonat / IK10	
Handgriff / Kappe   Handle / End cap		Neopren	
Zuleitung   Cable		10m H07RN-F 2 x 1,00mm <sup>2</sup>	
Stecker   Plug		optional	
Gas   Gas		Ex eb mb op is IIC T4 Gb	
Staub   Dust		Ex tb op is IIIC T105°C Db	
Kategorie   Category		2 G / 2 D	
Zonen   Zones		Zone 1, 2 / 21, 22	
Temperaturklasse   Temperature class		T4 +T105°C	
Prüfzertifikat   Test certificate		TÜV 18 ATEX 8191 X	

### ABMESSUNGEN | DIMENSIONS (IN MM)

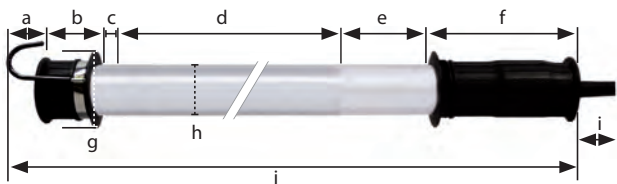

a	b	c	d	e	f	g	h	i	j
25	55	20	500	90	140	75	50	45	875

Gewicht | Weight: ca. 2,2kg

### ZUBEHÖR | ACCESSORIES



# EX TROLLEY LED 5024 | ATEX LED TROLLEY | ATEX LED TROLLEY

## Merkmale | Features



3x EX LED 5024  
3x EX LED 5024

Alu-Gehäuse  
alu housing

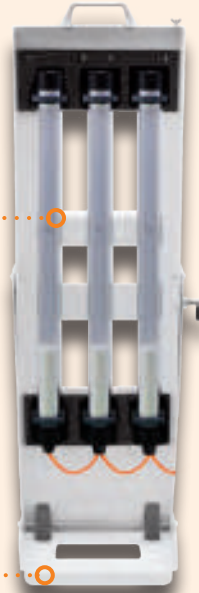

kippar mit Arretierung  
tiltable with lock

Kabelaufwicklung  
cable storage

Zuleitung 20m  
cable 20m

Rollen, ableitfähig  
castors, dissipative



## VORTEILE | ADVANTAGES

- mobile Beleuchtungslösung mit hoher Lichtausbeute
- kippar - flexible Ausleuchtung möglich
- verschiedene Spannungsvarianten erhältlich
- *mobile lighting solution with high light output*
- *tiltable - flexible illumination possible*
- *different voltage variants available*

## EINSATZBEREICHE | AREAS OF APPLICATION

- Inspektions- & Servicearbeiten
- Kontroll- & Reinigungsarbeiten
- Lackierereien
- *inspection and service work*
- *control & cleaning work*
- *paint shops*



# EX TROLLEY LED 5024 | ATEX LED TROLLEY | ATEX LED TROLLEY



## Mobile Beleuchtungslösung für den ATEX-Bereich.

- EX Leuchten: 3x KE-LED-EX 5024
- Leuchtmittel: 3x24 POWER LEDs / 6500K
- Diffusor: Diffusorfolie integriert
- Lumen: 4650 Lm (1650 Lm je Leuchte)
- Trolley: Aluminium mit 2 Rollen, ableitfähig
- Schutzart: IP68
- Schutzklasse: II bzw. III
- Zuleitung: 20m H07RN-F 2 x 2,5mm<sup>2</sup>
- Spannungsvarianten: 230V / 110V / 24V



## Mobile lighting solution for the ATEX area.

- EX lamps: 3x KE-LED-EX 5024
- Illuminant: 3x24 POWER LEDs / 6500K
- Diffusor: integrated diffuser film
- Lumen: 4650 Lm (1650 Lm per lamp)
- Trolley: aluminium with 2 castors, dissipative
- Protection category: IP68
- Protection class: II resp. III
- Cable: 20m H07RN-F 2 x 2,5mm<sup>2</sup>
- Voltage variants: 230V / 110V / 24V

### TECHNISCHE LEUCHTENDATEN | TECHNICAL LAMP DATA

<b>Art.-Nr.   Art.-No.</b>	<b>291956</b>
Nennspannung   <i>Nominal voltage</i>	220-240V AC
Schutzklasse   <i>Protection class</i>	II
Anzahl LED   <i>Number LED</i>	72 (3x24)
Leistung   <i>Power</i>	14,5 W (pro Leuchte   <i>per lamp</i> )
Nutzlicht   <i>Real lumen</i>	ca. 4650 Lm
Leuchte Energieeffizienzklasse <i>Luminaire energy efficiency class</i>	<b>A</b> <b>F</b>
Farbtemperatur   <i>Color temperature</i>	6500 K
Farbwiedergabe   <i>Color rendering</i>	> 70
Lebensdauer LED   <i>Lifetime LED</i>	> 50.000 h
Umgebungstemp.   <i>Ambient temp.</i>	-20°C - +50°C
IP Schutzart   <i>IP protection class</i>	IP68-50m / 5h
Diffusor   <i>Diffuser</i>	ja   yes
Schutzrohr   <i>Protective tube</i>	Polycarbonat / IK10
Trolley   <i>Trolley</i>	Aluminium, ableitfähig   <i>Aluminium, dissipative</i>
Zuleitung   <i>Cable</i>	20m H07RN-F 2 x 1,00mm <sup>2</sup>
Stecker   <i>Plug</i>	optional
Gas   <i>Gas</i>	Ex eb mb op is IIC T4 Gb
Staub   <i>Dust</i>	Ex tb op is IIC T105°C Db
Kategorie   <i>Category</i>	2 G / 2 D
Zonen   <i>Zones</i>	Zone 1, 2 / 21, 22
Temperaturklasse   <i>Temperature class</i>	T4 +T105°C
Prüfzertifikat Leuchte   <i>Test certificate lamp</i>	TÜV 18 ATEX 8191 X

### ABMESSUNGEN | DIMENSIONS (IN MM)

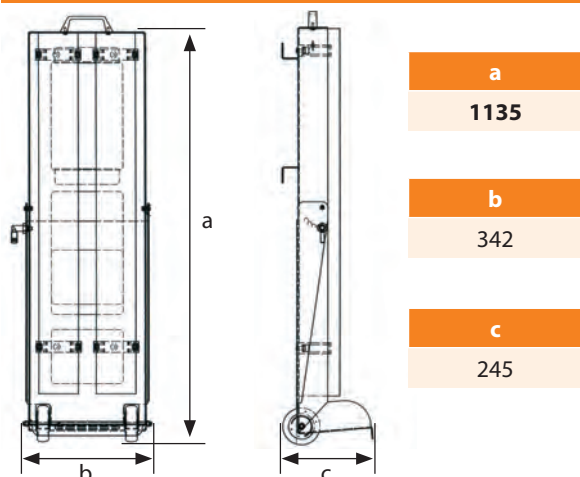

### optionales Zubehör | *optional accessories*



# ULTRA 3 LED | ATEX LED STRAHLER | ATEX LED FLOODLIGHT

## Merkmale | Features



Kunststoffgehäuse, antistatisch  
*plastic housing, antistatic*

gehärtetes Glas  
*hardened glass*

Diffusorfolie integriert  
*integrated diffuser film*

81x LEDs | 5000K  
*81x LEDs | 5000K*

Zuleitung H07RN-F  
*cable H07RN-F*

## vielseitig einsetzbar | versatile usable



Befestigung mittels Magnet  
*fastening with magnet*



Aufhängung für Gerüst & Geländer  
*suspension for scaffolding & railings*



Standfuß, verstellbar  
*stand, adjustable*



Praktisch stapelbar bei Lagerung  
*practically stackable when stored*



höhenverstellbares Stativ (1,38m - 2,50m)  
*(nur in Verbindung mit Standfuß anwendbar)*  
*height-adjustable tripod (1,38m - 2,50m) (can only be used in conjunction with a stand)*

## VORTEILE | ADVANTAGES

- hohe Lichtleistung
- geringes Gewicht von ca. 5kg
- vielseitiges Zubehör erhältlich
- *high light output*
- *low weight of about 5kg*
- *various accessories available*

## EINSATZBEREICHE | AREAS OF APPLICATION

- Inspektions- & Servicearbeiten
- Kanal- und Reinigungsarbeiten
- Lackierereien
- *inspection & service work*
- *sewer and cleaning work*
- *paint shops*



# ULTRA 3 LED | ATEX LED STRAHLER | ATEX LED FLOODLIGHT



## ATEX LED Strahler für anspruchsvolle und raue Arbeitsumgebung.

- Leuchtmittel: 81 LEDs / 5000K
- Gehäuse: Kunststoff, antistatisch
- Frontglas: gehärtetes Glas mit Schutzfolie
- Diffusor: Diffusorfolie integriert
- Schutzart: IP65
- Schutzklasse: III
- Zuleitung: 10m H07RN-F 2 x 2,5mm<sup>2</sup>
- Spannungsbereich: 24V - 48V AC/DC



## ATEX LED spotlight for demanding and harsh working environment.

- Illuminant: 81 LEDs / 5000K
- Housing: plastic, antistatic
- Front glass: tempered glass with protective film
- Diffusor: integrated diffuser film
- Protection category: IP65
- Protection class: III
- Cable: 10m H07RN-F 2 x 2,5mm<sup>2</sup>
- Voltage range: 24V - 48V AC/DC

### TECHNISCHE DATEN | TECHNICAL DATA

Art.-Nr.   Art.-No.	290796 (Version 10m Zuleitung   Version 10m cable)
Art.-Nr.   Art.-No.	290799 (Version 30m Zuleitung   Version 30m cable)
Nennspannung   Nominal voltage	24V - 48V AC/DC
Anzahl LED   Number LED	81
Leistung   Power	35 W
Nutzlicht   Real lumen	ca. 4100 Lm
Farbtemperatur   Color temperature	5000 K
Umgebungstemp.   Ambient temp.	-20°C - +50°C
IP Schutzart   IP protection class	IP65
Diffusor   Diffuser	ja   yes
Gehäuse   Housing	Kunststoff, antistatisch / plastic, antistatic
Frontglas   Front glass	gehärtetes Glas mit Schutzfolie / tempered glass with protective film
Zuleitung   Cable	10m bzw. 30m H07RN-F 2 x 2,5mm <sup>2</sup>
Stecker   Plug	optional
EX Schutzart   EX Protection	Ex ib mb IIC T4 Gb / Ex ib mb IIIC T135°C Db
Zonen   Zones	Zone 1, 2 / 21, 22
Temperaturklasse   Temperature class	T4 +T135°C
Prüfzertifikat   Test certificate	KIWA 19ATEX0039 X

### ABMESSUNGEN | DIMENSIONS (IN MM)



a	b	c
378	140	220

#### Gewicht | Weight

ca. 4,5 kg (ohne Kabel | w/o cable)

### Zubehör | Accessories



# ATEX LEUCHTEN-SET | ATEX LUMINAIRE-SET

## Merkmale | Features

### ULTRA 5024 EX-TRA



LED

2x  
1650  
Lumen

2x  
4100  
Lumen

230V  
24V

#### SET BEINHALTET | SET INCLUDES

Art.-Nr.   Art.-No.	148201
Handleuchte   Hand lamp	2x KE-LED-EX 5024 / 24V
Strahler   Floodlight	2x Ultra 3 LED / 24V
EX Stecker   EX plug	inkl. ATX Stecker   incl. ATX plugs
EX Trafo   EX-Transformer	EX 400VA / 230V-24V
	4x Ausgang   4x output
Zonen   Zones	1, 2, 21, 22
(Preis auf Anfrage   price on request)	

## Merkmale | Features

### LED-EX 18-06 TR



LED

2x  
520  
Lumen

2x  
1000  
Lumen

230V  
24V

#### SET BEINHALTET | SET INCLUDES

Art.-Nr.   Art.-No.	148204
Handleuchte   Hand lamp	2x KE-LED-EX 4006 / 24V
Leuchte 360°   Lamp 360°	2x KE-LED-EX 5018 / 24V - 360°
Zonen   Zones	1, 2, 21, 22
CEE Stecker   CEE plug	inkl. CEE Stecker   incl. CEE plugs
Trafo   Transformer	250VA / 230V-24V (NON-EX)
	4x Ausgang   4x output
<small>Trafo und Stecker ohne EX-Schutz, müssen ausserhalb des EX-Bereich betrieben werden Transformer and plug without EX protection must be operated outside the EX area</small>	
(Preis auf Anfrage   price on request)	

## Merkmale | Features

### Ultra 4006 EX-TRA



LED

2x  
520  
Lumen

1x  
4100  
Lumen

230V  
24V

#### Set beinhaltet | Set includes

Art.-Nr.   Art.-No.	148205
Handleuchte   Hand lamp	2x KE-LED-EX 4006 / 24V
Strahler   Floodlight	2x Ultra 3 LED / 24V
EX Stecker   EX plug	inkl. ATX Stecker   incl. ATX plugs
EX Trafo   EX-Transformer	EX 400VA / 230V-24V
	4x Ausgang   4x output
Zonen   Zones	1, 2, 21, 22
(Preis auf Anfrage   price on request)	



# KIRA ATEX Rohrleuchten - Einsatzgebiete

## KIRA ATEX tube luminaires - areas of application



**Kläranlagen**  
*sewage treatment plants*



**Fahrzeugbau**  
*vehicle construction*



**Schiffswerften**  
*shipyard*



**Offshore**  
*offshore*



**Maschinenbau**  
*mechanical engineering*



**Reinraumtechnik**  
*clean room technology*



**Petroindustrie**  
*petrochemical industry*



# KE-LED-EX 3010 | ATEX LED ROHRLEUCHE | ATEX LED TUBE LUMINAIRE

## Merkmale | Features

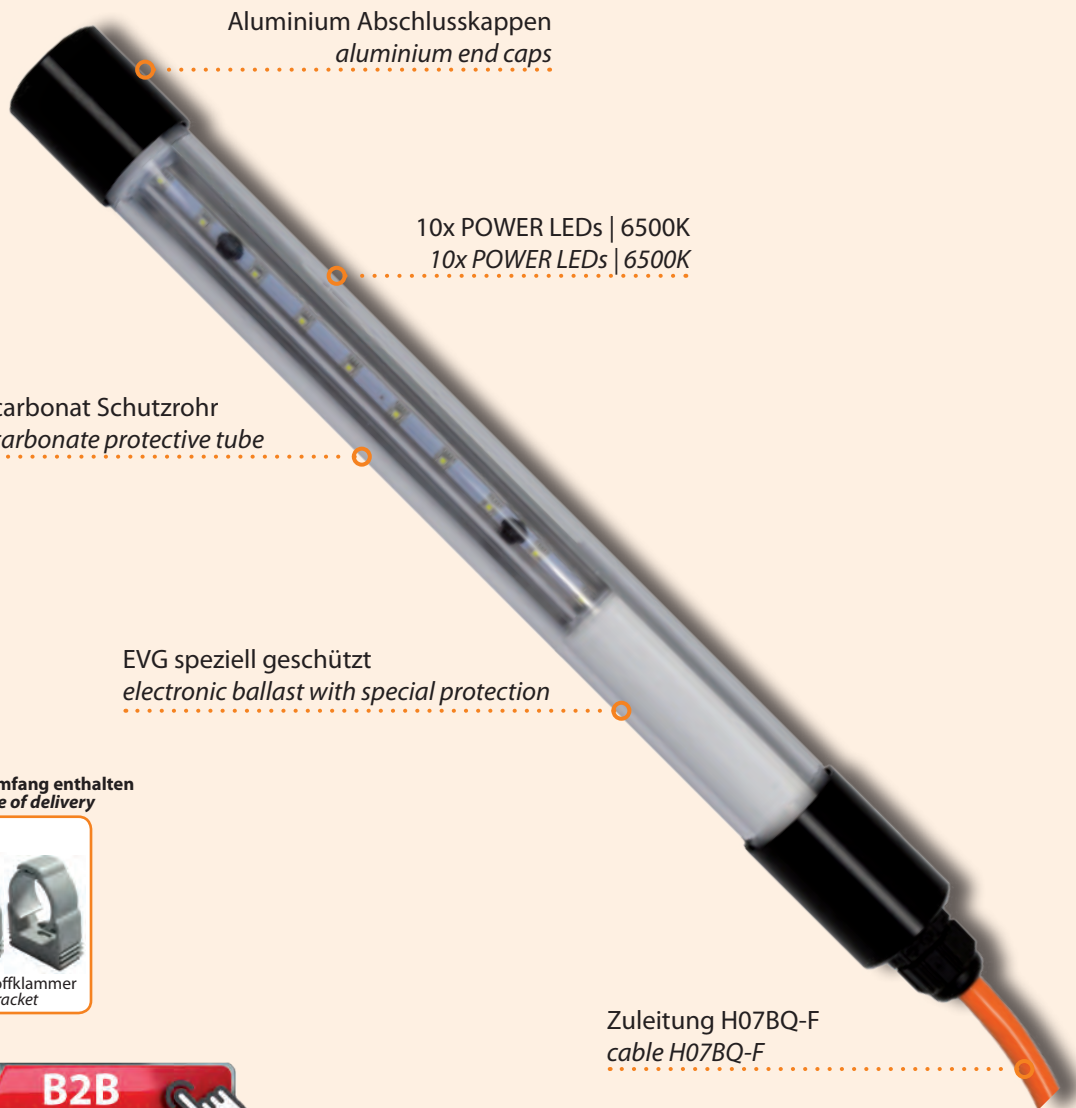

Aluminium Abschlusskappen  
*aluminium end caps*

10x POWER LEDs | 6500K  
*10x POWER LEDs | 6500K*

Polycarbonat Schutzrohr  
*polycarbonate protective tube*

EVG speziell geschützt  
*electronic ballast with special protection*

im Lieferumfang enthalten  
*in the scope of delivery*



2x Kunststoffklammer  
*2x plastic bracket*

Zuleitung H07BQ-F  
*cable H07BQ-F*



## VORTEILE | ADVANTAGES

- kompaktes und schlankes Einbaumaß
- hohe Lichtleistung
- Quick-Connect Klammern für schnelle Montage
- *compact and slim installation dimensions*
- *high light output*
- *quick-connect brackets for quick installation*

## EINSATZBEREICHE | AREAS OF APPLICATION

- Tank- und Silofahrzeuge
- Flugfeldbetankungsfahrzeuge
- Maschinen und Anlagen im EX-Bereich
- *tank and silo vehicles*
- *airfield refueling vehicles*
- *machines and systems in EX areas*



# KE-LED-EX 3010 | ATEX LED ROHRLEUCHE | ATEX LED TUBE LUMINAIRE



**Kompakte ATEX Rohrleuchte, ideal zur Montage in Maschinen, Fahrzeugen und elektrischen Anlagen.**

- Leuchtmittel: 10 POWER LEDs / 6500K
- Schutzrohr: Polycarbonat, 30mm Ø
- Abschlusskappen: Aluminium, schwarz eloxiert
- Befestigung: 2x Kunststoffklammer
- Schutzart: IP68-50m / 5h
- Schutzklasse: III
- Zuleitung: 10m H07RN-F 2 x 1,00mm<sup>2</sup>
- Spannungsvariante: 24V



**Compact ATEX tube light, ideal for mounting in machines, vehicles and electrical systems.**

- Illuminant: 10 POWER LEDs / 6500K
- Protective tube: polycarbonate, 30mm Ø
- End caps: aluminium, black anodized
- Fixation: 2x plastic bracket
- Protection category: IP68-50m / 5h
- Protection class: III
- Cable: 10m H07RN-F 2 x 1,00mm<sup>2</sup>
- Voltage variant: 24V

## TECHNISCHE DATEN | TECHNICAL DATA

<b>Art.-Nr.   Art.-No.</b>	<b>150100</b>
Nennspannung   <i>Nominal voltage</i>	24V AC/DC
Strom   <i>Current</i>	0,215 A
Schutzklasse   <i>Protection class</i>	III
Anzahl LED   <i>Number LED</i>	10
Leistung   <i>Power</i>	6 Watt
Nutzlicht   <i>Real lumen</i>	600 Lm
Leuchte Energieeffizienzklasse <i>Luminaire energy efficiency class</i>	<b>A+</b> <b>F</b>
Farbtemperatur   <i>Color temperature</i>	6500 K
Farbwiedergabe   <i>Color rendering</i>	> 70
Lebensdauer LED   <i>Lifetime LED</i>	> 50.000 h
Umgebungstemp.   <i>Ambient temp.</i>	-20°C - +50°C
IP Schutzart   <i>IP protection class</i>	IP68-50m / 5h
Diffusor   <i>Diffuser</i>	optional
Schutzrohr   <i>Protective tube</i>	Polycarbonat / IK10
Abschlusskappen   <i>End caps</i>	Neopren
Zuleitung   <i>Cable</i>	10m H07BQ-F 2 x 1,5mm <sup>2</sup>
Stecker   <i>Plug</i>	optional
Gas   <i>Gas</i>	Ex eb mb op is IIC T4 Gb
Staub   <i>Dust</i>	Ex tb op is IIIC T105°C Db
Kategorie   <i>Category</i>	2 G / 2 D
Zonen   <i>Zones</i>	Zone 1, 2 / 21, 22
Temperaturklasse   <i>Temperature class</i>	T4 +T105°C
Prüfzertifikat   <i>Test certificate</i>	TÜV 18 ATEX 8240

## ABMESSUNGEN | DIMENSIONS (IN MM)

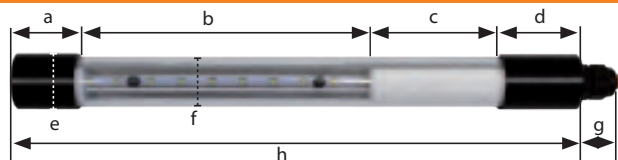

a	b	c	d	e	f	g	h
35	175	75	45	33	30	25	330

Gewicht | *Weight*: ca. 1,2kg

## ZUBEHÖR | ACCESSORIES



# KE-LED-EX 4003 | ATEX LED ROHRLEUCHE | ATEX LED TUBE LUMINAIRE

## Merkmale | Features



Aluminium Abschlusskappen  
*aluminium end caps*

3x POWER LEDs | 6500K  
3x POWER LEDs | 6500K

Polycarbonat Schutzrohr  
*polycarbonate protective tube*



Farbvarianten auf Anfrage erhältlich  
*Color vivants available upon request*

EVG speziell geschützt  
*electronic ballast with special protection*

im Lieferumfang enthalten  
*in the scope of delivery*



2x Kunststoffklammer  
*2x plastic bracket*

Zuleitung H07BQ-F  
*cable H07BQ-F*



## VORTEILE | ADVANTAGES

- kleines Einbaumaß für beengte Bereiche
- robustes, schlagfestes Polycarbonatrohr
- verschiedene Spannungsvarianten erhältlich
- *small installation dimensions for cramped areas*
- *robust, impact-resistant polycarbonate tube*
- *different voltage variants available*

## EINSATZBEREICHE | AREAS OF APPLICATION

- Tank- und Silofahrzeuge
- Flugfeldbetankungsfahrzeuge
- Maschinen und Anlagen im EX-Bereich
- *tank and silo vehicles*
- *airfield refueling vehicles*
- *machines and systems in EX areas*

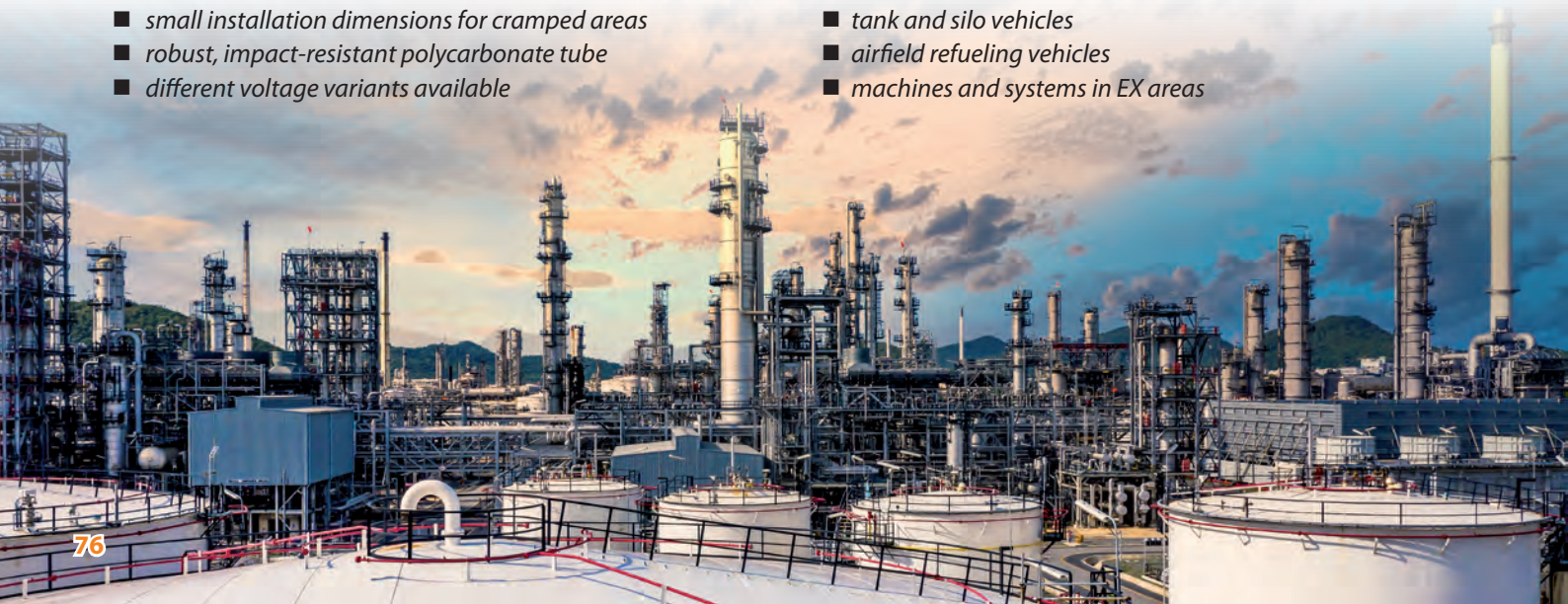

# KE-LED-EX 4003 | ATEX LED ROHRLEUCHTE | ATEX LED TUBE LUMINAIRE



**Kompakte ATEX Rohrleuchte, ideal zur Montage in Maschinen, Fahrzeugen und elektrischen Anlagen.**

- Leuchtmittel: 3 POWER LEDs / 6500K
- Schutzrohr: Polycarbonat, 40mm Ø
- Abschlusskappen: Aluminium, schwarz eloxiert
- Befestigung: 2x Kunststoffklammer
- Schutzart: IP68-50m / 5h
- Schutzklasse: II bzw. III
- Zuleitung: 10m H07BQ-F 2 x 1,5mm<sup>2</sup>
- Spannungsvarianten: 230V / 110V / 42V / 24V / 12V



**Compact ATEX tube light, ideal for mounting in machines, vehicles and electrical systems.**

- Illuminant: 3 POWER LEDs / 6500K
- Protective tube: polycarbonate, 40mm Ø
- End caps: aluminium, black anodized
- Fixation: 2x plastic bracket
- Protection category: IP68-50m / 5h
- Protection class: II resp. III
- Cable: 10m H07BQ-F 2 x 1,5mm<sup>2</sup>
- Voltage variants: 230V / 110V / 42V / 24V / 12V

## TECHNISCHE DATEN | TECHNICAL DATA

Art.-Nr.   Art.-No.	147100	147110	147120	147130	147140
Nennspannung   Nominal voltage	220-240V AC	110V AC/DC	42V AC/DC	24V AC/DC	12V AC/DC
Strom   Current	0,03 A	0,025 A	0,075 A	0,10 A	0,20 A
Schutzklasse   Protection class	II	II	II	III	III
Anzahl LED   Number LED	3	3	3	3	3
Leistung   Power	3,3 Watt	3,0 Watt	3,8 Watt	3,0 Watt	2,8 Watt
Nutzlicht   Real lumen	200 Lm	185 Lm	180 Lm	255 Lm	235 Lm
Leuchte Energieeffizienzklasse Luminaire energy efficiency class					
Farbtemperatur   Color temperature	6500 K				
Farbwiedergabe   Color rendering	> 70				
Lebensdauer LED   Lifetime LED	> 50.000 h				
Umgebungstemp.   Ambient temp.	-20°C - +50°C				
IP Schutzart   IP protection class	IP68-50m / 5h				
Diffusor   Diffuser	optional				
Schutzrohr   Protective tube	Polycarbonat / IK10				
Abschlusskappen   End caps	Aluminium				
Zuleitung   Cable	10m H07BQ-F 2 x 1,5mm <sup>2</sup>				
Stecker   Plug	optional				
Gas   Gas	Ex eb mb op is IIC T4 Gb				
Staub   Dust	Ex tb op is IIIC T105°C Db				
Kategorie   Category	2 G / 2 D				
Zonen   Zones	Zone 1, 2 / 21, 22				
Temperaturklasse   Temperature class	T4 +T105°C				
Prüfzertifikat   Test certificate	TÜV 18 ATEX 8184				

## ABMESSUNGEN | DIMENSIONS (IN MM)



a	b	c	d	e	f	g	h
35	100	120	45	43	40	20	300

Gewicht | Weight: ca. 1,56kg

## ZUBEHÖR | ACCESSORIES



# KE-LED-EX 4006-O | ATEX LED ROHRLEUCHE | ATEX LED TUBE LUMINAIRE

## Merkmale | Features

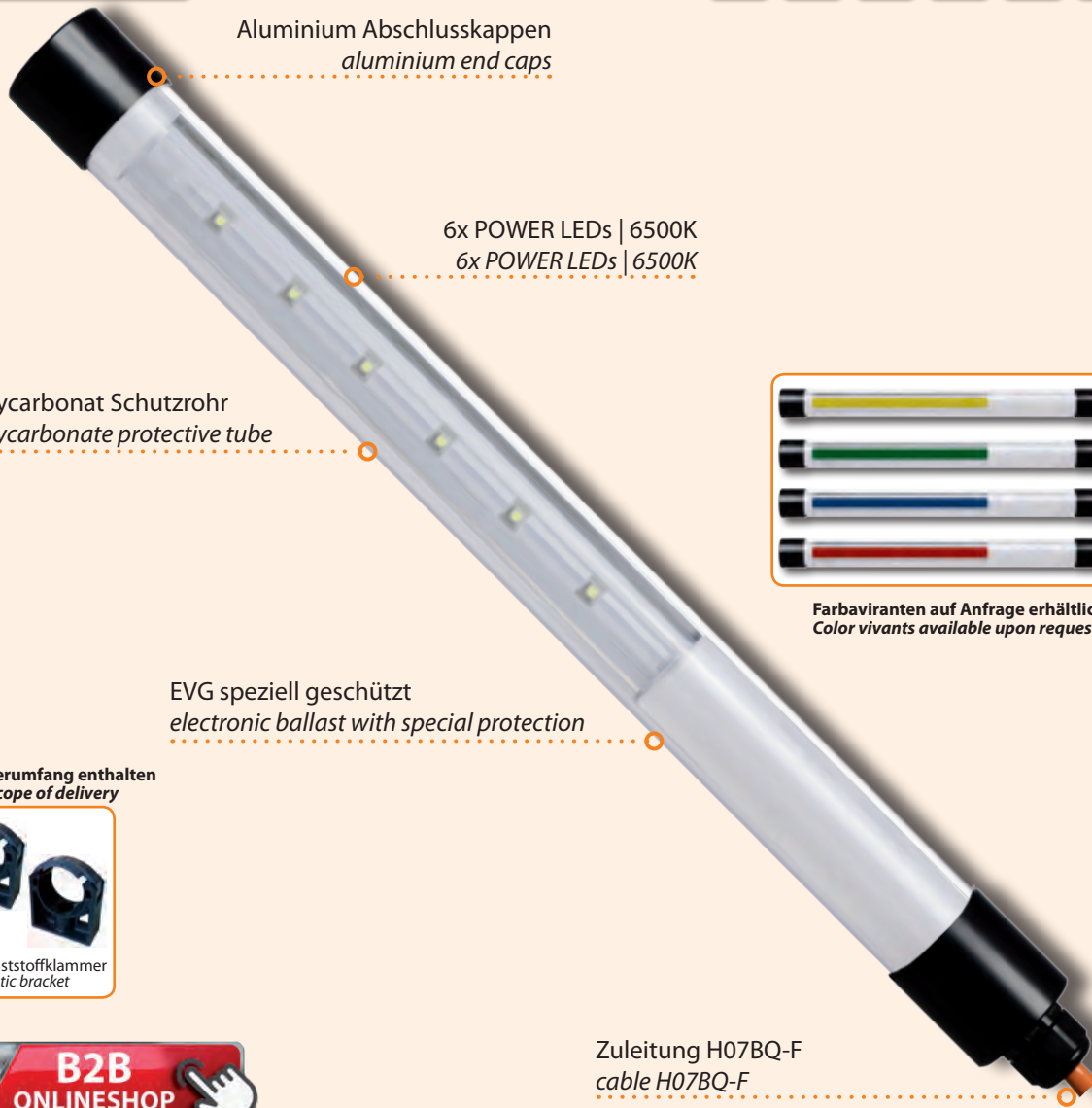

Aluminium Abschlusskappen  
*aluminium end caps*

6x POWER LEDs | 6500K  
6x POWER LEDs | 6500K

Polycarbonat Schutzrohr  
*polycarbonate protective tube*



Farbvarianten auf Anfrage erhältlich  
*Color vivants available upon request*

EVG speziell geschützt  
*electronic ballast with special protection*

im Lieferumfang enthalten  
*in the scope of delivery*



2x Kunststoffklammer  
*2x plastic bracket*



Zuleitung H07BQ-F  
*cable H07BQ-F*

## VORTEILE | ADVANTAGES

- hohe Lichtleistung trotz schlanker Bauform
- robustes, schlagfestes Polycarbonatrohr
- homogenes und blendfreies Licht
- *high light output despite slim design*
- *robust, impact-resistant polycarbonate tube*
- *homogeneous and glare-free light*

## EINSATZBEREICHE | AREAS OF APPLICATION

- Tank- und Silofahrzeuge
- Flugfeldbetankungsfahrzeuge
- Absauganlagen im EX-Bereich
- *tank and silo vehicles*
- *airfield refueling vehicles*
- *extraction systems in the EX area*

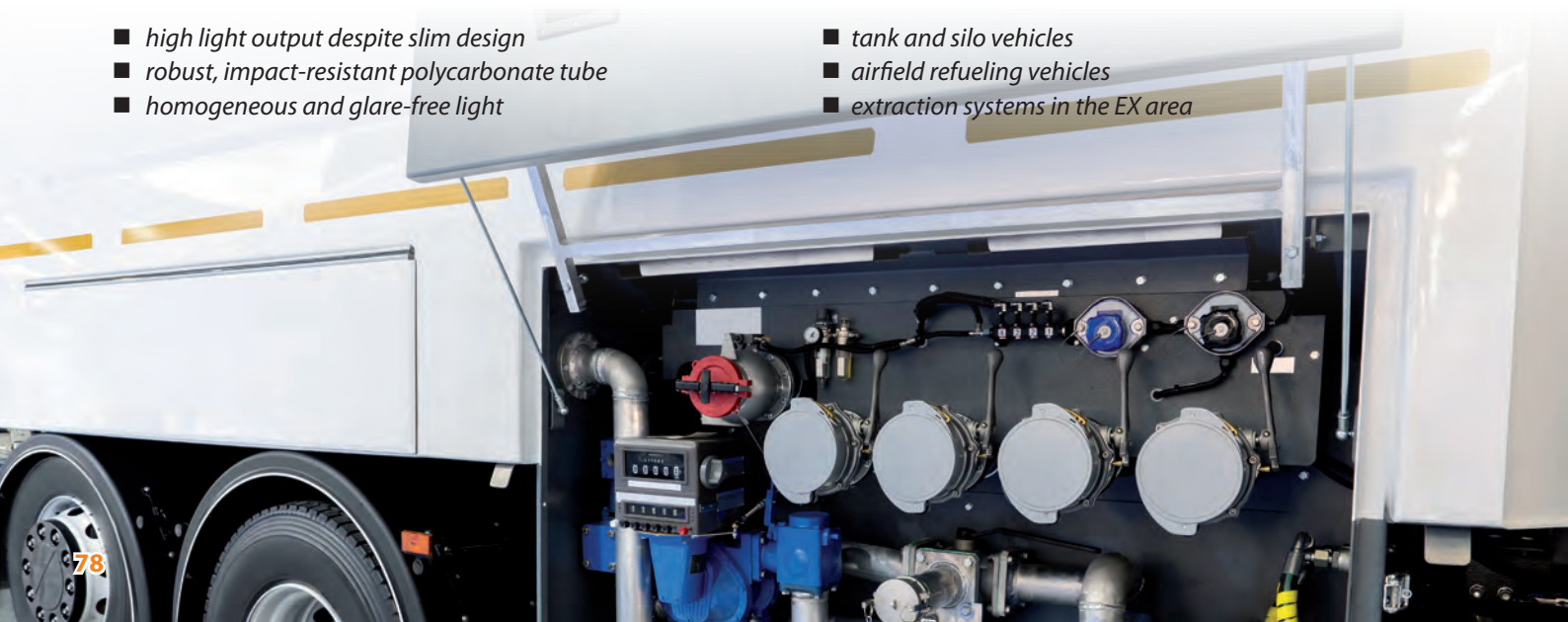

# KE-LED-EX 4006-O | ATEX LED ROHRLEUCHTE | ATEX LED TUBE LUMINAIRE



**ATEX LED Rohrleuchte mit hoher Lichtausbeute, geeignet für Maschinen- und Fahrzeuge.**

- Leuchtmittel: 6 POWER LEDs / 6500K
- Schutzrohr: Polycarbonat, 40mm Ø
- Abschlusskappen: Aluminium, schwarz eloxiert
- Befestigung: 2x Kunststoffklammer
- Schutzart: IP68-50m / 5h
- Schutzklasse: II bzw. III
- Zuleitung: 10m H07BQ-F 2 x 1,5mm<sup>2</sup>
- Spannungsvarianten: 230V / 110V / 42V / 24V / 12V



**ATEX LED tube luminaire with high light output, suitable for machines and vehicles.**

- Illuminant: 6 POWER LEDs / 6500K
- Protective tube: polycarbonate, 40mm Ø
- End caps: aluminium, black anodized
- Fixation: 2x plastic bracket
- Protection category: IP68-50m / 5h
- Protection class: II resp. III
- Cable: 10m H07BQ-F 2 x 1,5mm<sup>2</sup>
- Voltage variants: 230V / 110V / 42V / 24V / 12V

## TECHNISCHE DATEN | TECHNICAL DATA

Art.-Nr.   Art.-No.	146100	146110	146120	146130	146140
Nennspannung   Nominal voltage	220-240V AC	110V AC/DC	42V AC/DC	24V AC/DC	12V AC/DC
Strom   Current	0,05 A	0,05 A	0,11 A	0,18 A	0,29 A
Schutzklasse   Protection class	II	II	II	III	III
Anzahl LED   Number LED	6	6	6	6	6
Leistung   Power	7 Watt	6,4 Watt	5,5 Watt	5,3 Watt	4,2 Watt
Nutzlicht   Real lumen	520 Lm	460 Lm	400 Lm	520 Lm	370 Lm
Leuchte Energieeffizienzklasse Luminaire energy efficiency class					
Farbtemperatur   Color temperature			6500 K		
Farbwiedergabe   Color rendering			> 70		
Lebensdauer LED   Lifetime LED			> 50.000 h		
Umgebungstemp.   Ambient temp.			-20°C - +50°C		
IP Schutzart   IP protection class			IP68-50m / 5h		
Diffusor   Diffuser			optional		
Schutzrohr   Protective tube			Polycarbonat / IK10		
Abschlusskappen   End caps			Aluminium		
Zuleitung   Cable			10m H07BQ-F 2 x 1,5mm <sup>2</sup>		
Stecker   Plug			optional		
Gas   Gas			Ex eb mb op is IIC T4 Gb		
Staub   Dust			Ex tb op is IIIC T105°C Db		
Kategorie   Category			2 G / 2 D		
Zonen   Zones			Zone 1, 2 / 21, 22		
Temperaturklasse   Temperature class			T4 +T105°C		
Prüfzertifikat   Test certificate			TÜV 18 ATEX 8184		

## ABMESSUNGEN | DIMENSIONS (IN MM)

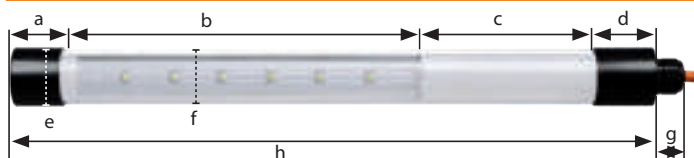

a	b	c	d	e	f	g	h
35	265	125	45	43	40	20	470
Gewicht   Weight: ca. 1,65kg							

## ZUBEHÖR | ACCESSORIES



# KE-LED-EX 5018 | ATEX LED ROHRLEUCHE | ATEX LED TUBE LUMINAIRE

## Merkmale | Features



Aluminium Abschlusskappen  
aluminium end caps

18x POWER LEDs | 6500K  
18x POWER LEDs | 6500K

Polycarbonat Schutzrohr  
polycarbonate protective tube

Diffusorfolie integriert  
integrated diffuser film

EVG speziell geschützt  
electronic ballast with special protection

Zuleitung H07BQ-F  
cable H07BQ-F

Silo-Aufhängung optional  
silo suspension optional



## VORTEILE | ADVANTAGES

- 360° Ausleuchtung, hell und blendfrei
- für Festmontage und mobile Arbeiten geeignet
- optionale Silo-Aufhängung erhältlich
- 360° illumination, bright and glare-free
- suitable for fixed installation and mobile work
- optional silo suspension available

## Einsatzbereiche | Areas of application

- Inspektions- & Servicearbeiten
- Reinigungsarbeiten in Tank- und Siloanlagen
- Professionelle Tankfahrzeugreinigung
- inspection and service work
- cleaning work in tank and silo systems
- professional tanker cleaning



# KE-LED-EX 5018 | ATEX LED ROHRLEUCHE | ATEX LED TUBE LUMINAIRE



## ATEX LED Rohrleuchte mit 360° Ausleuchtung.

- Leuchtmittel: 18 POWER LEDs / 6500K
- Schutzrohr: Polycarbonat, schlagfest, 50mm Ø
- Abschlusskappen: Aluminium, schwarz eloxiert
- option. Befestigung: Silo-Aufhängung oder Klammern
- Schutzart: IP68-50m / 5h
- Schutzklasse: III
- Zuleitung: 10m H07BQ-F 2 x 1,5mm<sup>2</sup>
- Spannungsvariante: 24V



## ATEX LED hand lamp with 360° illumination.

- Illuminant: 18 POWER LEDs / 6500K
- Protective tube: polycarbonate, 50mm Ø
- End caps: aluminium, black anodized
- Fixation optional: silo suspension or brackets
- Protection category: IP68-50m / 5h
- Protection class: III
- Cable: 10m H07BQ-F 2 x 1,5mm<sup>2</sup>
- Voltage variant: 24V

### TECHNISCHE DATEN | TECHNICAL DATA

Art.-Nr.   Art.-No.	149130
Nennspannung   Nominal voltage	24V AC/DC
Strom   Current	0,33 A
Schutzklasse   Protection class	III
Anzahl LED   Number LED	18
Leistung   Power	10 Watt
Nutzlicht   Real lumen	1000 Lm
Leuchte Energieeffizienzklasse Luminaire energy efficiency class	<b>A</b> <b>F</b>
Farbtemperatur   Color temperature	6500 K
Farbwiedergabe   Color rendering	> 70
Lebensdauer LED   Lifetime LED	> 50.000 h
Umgebungstemp.   Ambient temp.	-20°C - +50°C
IP Schutzart   IP protection class	IP68-50m / 5h
Diffusor   Diffuser	ja   yes
Schutzrohr   Protective tube	Polycarbonat / IK10
Abschlusskappen   End caps	Aluminium
Zuleitung   Cable	10m H07BQ-F 2 x 1,5mm <sup>2</sup>
Stecker   Plug	optional
Gas   Gas	Ex eb mb op is IIC T4 Gb
Staub   Dust	Ex tb op is IIIC T105°C Db
Kategorie   Category	2 G / 2 D
Zonen   Zones	Zone 1, 2 / 21, 22
Temperaturklasse   Temperature class	T4 +T105°C
Prüfzertifikat   Test certificate	TÜV 18 ATEX 8191 X

### ABMESSUNGEN | DIMENSIONS (IN MM)

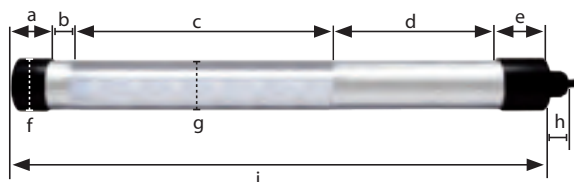

a	b	c	d	e	f	g	h	i
35	45	225	175	45	53	50	20	525

Gewicht | Weight: ca. 1,5kg

### ZUBEHÖR | ACCESSORIES



# KE-LED-EX 5024 | ATEX LED ROHRLEUCHE | ATEX LED TUBE LUMINAIRE

## Merkmale | Features



Aluminium Abschlusskappen  
*aluminium end caps*

24x POWER LEDs | 6500K  
*24x POWER LEDs | 6500K*

Polycarbonat Schutzrohr  
*polycarbonate protective tube*

Diffusorfolie integriert  
*integrated diffuser film*

auch als Durchgangsversion erhältlich  
*also available as a through-wiring version*



im Lieferumfang enthalten  
*in the scope of delivery*



2x Kunststoffklammer  
*2x plastic bracket*

EVG speziell geschützt  
*electronic ballast with special protection*



Zuleitung H07BQ-F  
*cable H07BQ-F*

## VORTEILE | ADVANTAGES

- extrem hell und lichtstark
- robustes, schlagfestes Polycarbonatrohr
- homogenes und blendfreies Licht
- *extremely bright and powerful*
- *robust, impact-resistant polycarbonate tube*
- *homogeneous and glare-free light*

## EINSATZBEREICHE | AREAS OF APPLICATION

- Tank- und Silofahrzeuge
- Kläranlagen und Kanalanlagen
- Absauganlagen im EX-Bereich
- *tank and silo vehicles*
- *sewage treatment plants and sewage systems*
- *extraction systems in the EX area*

# KE-LED-EX 5024 | ATEX LED ROHRLEUCHE | ATEX LED TUBE LUMINAIRE



**ATEX LED Rohrleuchte mit hoher Lichtausbeute, geeignet für Anlagen und Maschinen.**

- Leuchtmittel: 24 POWER LEDs / 6500K
- Schutzrohr: Polycarbonat, 50mm Ø
- Abschlusskappen: Aluminium, schwarz eloxiert
- Befestigung: 2x Kunststoffklammer
- Schutzart: IP68-50m / 5h
- Schutzklasse: II bzw. III
- Zuleitung: 10m H07BQ-F 2 x 1,5mm<sup>2</sup>
- Spannungsvarianten: 230V / 110V / 24V



**ATEX LED tube luminaire with high light output, suitable for plants and machines.**

- Illuminant: 24 POWER LEDs / 6500K
- Protective tube: polycarbonate, 50mm Ø
- End caps: aluminium, black anodized
- Fixation: 2x plastic bracket
- Protection category: IP68-50m / 5h
- Protection class: II resp. III
- Cable: 10m H07BQ-F 2 x 1,5mm<sup>2</sup>
- Voltage variants: 230V / 110V / 24V

## TECHNISCHE DATEN | TECHNICAL DATA

Art.-Nr.   Art.-No.	148100	148110	148130
Nennspannung   Nominal voltage	220-240V AC	110V AC/DC	24V AC/DC
Strom   Current	0,075 A	0,135 A	0,550 A
Schutzklasse   Protection class	II	II	III
Anzahl LED   Number LED	24	24	24
Leistung   Power	14,5 Watt	14,5 Watt	15,5 Watt
Nutzlicht   Real lumen	1550 Lm	1600 Lm	1650 Lm
Leuchte Energieeffizienzklasse Luminaire energy efficiency class			
Farbtemperatur   Color temperature		6500 K	
Farbwiedergabe   Color rendering		> 70	
Lebensdauer LED   Lifetime LED		> 50.000 h	
Umgebungstemp.   Ambient temp.		-20°C - +50°C	
IP Schutzart   IP protection class		IP68-50m / 5h	
Diffusor   Diffuser		ja   yes	
Schutzrohr   Protective tube		Polycarbonat / IK10	
Abschlusskappen   End caps		Aluminium	
Zuleitung   Cable		10m H07BQ-F 2 x 1,5mm <sup>2</sup>	
Stecker   Plug		optional	
Gas   Gas		Ex eb mb op is IIC T4 Gb	
Staub   Dust		Ex tb op is IIIC T105°C Db	
Kategorie   Category		2 G / 2 D	
Zonen   Zones		Zone 1, 2 / 21, 22	
Temperaturklasse   Temperature class		T4 +T105°C	
Prüfzertifikat   Test certificate		TÜV 18 ATEX 8191 X	

## ABMESSUNGEN | DIMENSIONS (IN MM)



a	b	c	d	e	f	g	h	i
35	25	500	165	45	53	50	25	770

Gewicht | Weight: ca. 2,2kg

## ZUBEHÖR | ACCESSORIES



## ZUBEHÖR | ACCESSORIES

ATEX-STECKER   ATEX-PLUGS		Art.-Nr.
CEAG EX Stecker 230V   CEAG EX plug 230V	200-250V / 3 pol. / 16A	290843
CEAG EX Stecker 110V   CEAG EX plug 110V	110-130V / 3 pol. / 16A	290847
CEAG EX Stecker 42V   CEAG EX plug 42V	40-50V / 2 pol. / 16A	290842
CEAG EX Stecker 24V   CEAG EX plug 24V	20-25V / 2 pol. / 16A	291142
ATX EX Stecker 230V   ATX EX plug 230V	200-250V / 3 pol. / 16A	291145
ATX EX Stecker 24V   ATX EX plug 24V	20-25V / 2 pol. / 16A	291143

ATEX-KUPPLUNG   ATEX-COUPLING		Art.-Nr.
CEAG EX Kupplung 230V   CEAG EX coupling 230V	200-250V / 3 pol. / 16A	291464
CEAG EX Kupplung 110V   CEAG EX coupling 110V	110-130V / 3 pol. / 16A	291484
CEAG EX Kupplung 42V   CEAG EX coupling 42V	40-50V / 2 pol. / 16A	291479
CEAG EX Kupplung 24V   CEAG EX coupling 24V	20-25V / 2 pol. / 16A	291475
ATX EX Kupplung 230V   ATX EX coupling 230V	200-250V / 3 pol. / 16A	291146
ATX EX Kupplung 24V   ATX EX coupling 24V	20-25V / 2 pol. / 16A	291470

BEFESTIGUNGSKLAMMERN   MOUNTING BRACKETS		für   for	Art.-Nr.
BFK D30 EX Kunststoffklammer   plastic bracket	KE-LED-EX 3010	290746	
BFK D40 EX Kunststoffklammer   plastic bracket	KE-LED-EX 4003 / 4006	290432	
BFK D50 EX Kunststoffklammer   plastic bracket	KE-LED-EX 5018 / 5024	290431	

MAGNETBEFESTIGUNG   MAGNETIC ATTACHEMENT		für   for	Art.-Nr.
KM 30-EX-KL Magnet mit Klammer BFK D30   magnet with clamp BFK D30	KE-LED-EX 3010	290527	
KM 40-EX-KL Magnet mit Klammer BFK D40   magnet with clamp BFK D40	KE-LED-EX 4003 / 4006	291275	
KM 50-EX-KL Magnet mit Klammer BFK D50   magnet with clamp BFK D50	KE-LED-EX 5018 / 5024	290515	

SCHUTZFOLIE ANTISTATISCH   PROTECTIVE FILM ANTISTATIC		für   for	Art.-Nr.
SFO-EX 4003	KE-LED-EX 4003	291281	
SFO-EX 4006	KE-LED-EX 4006	291249	
SFO-EX 5018	KE-LED-EX 5018	291658	
SFO-EX 5024	KE-LED-EX 5024	291654	

AUFHÄNGEVORRICHTUNGEN   HANGING DEVICES		für   for	Art.-Nr.
AK-EX Kettenaufhängung   chain hang up	KE-LED-EX 50xx	291385	
AHD-EX Duo-Aufhängehaken   duo hook	KE-LED-EX 50xx	291429	
AS-EX Siloaufhängung   silo hang up	KE-LED-EX 5018	291411	

EDELSTAHL-STANDFUSS   STAINLESS STEEL STAND		für   for	Art.-Nr.
ST-EX Edelstahl Standfuß   stainless steel stand	KE-LED-EX 5024	291388	

ATEX TRANSFORMATOR   ATEX TRANSFORMER		Art.-Nr.
ATEX Trafo 400VA 230-24   ATEX transformer 400VA 230-24	141251	

TRANSFORMATOREN FÜR SCHUTZKLEINSPANNUNG   TRANSFORMERS FOR SAFETY EXTRA-LOW VOLTAGE		Art.-Nr.
<b>Typ 230V - 24V (OHNE EX-SCHUTZ   NON-EX-PROOF)</b>		
SELV 25/1-24   230V-24V   25VA   1x24V CEE-Steckdose/Vergussgehäuse   1x24V CEE socket/plastic housing	141133	
SELV 60/1-24   230V-24V   60VA   1x24V CEE-Steckdose/Gummigehäuse   1x24V CEE socket/rubber housing	141124	
SELV 100/1-24   230V-24V   100VA   1x24V CEE-Steckdose/Gummigehäuse   1x24V CEE socket/rubber housing	141100	
SELV 160/2-24   230V-24V   160VA   2x24V CEE-Steckdose/Gummigehäuse   2x24V CEE socket/rubber housing	141160	
SELV 250/2-24   230V-24V   250VA   2x24V CEE-Steckdose/Gummigehäuse   2x24V CEE socket/rubber housing	141170	
SELV 250/4-24   230V-24V   250VA   4x24V CEE-Steckdose/Gummigehäuse   4x24V CEE socket/rubber housing	141128	

# ATEX Akku & Batterie Leuchten - Einsatzgebiete

## ATEX Accu & Battery lamps - areas of application



# ULTRAXL LED | ATEX AKKU LED STRAHLER | ATEX ACCU LED FLOODLIGHT

## Merkmale | Features



Kunststoffgehäuse, antistatisch  
*plastic housing, antistatic*

gehärtetes Glas  
*hardened glass*

Diffusorfolie integriert  
*integrated diffuser film*

81x LEDs | 5000K  
*81x LEDs | 5000K*

LiPo-Akku, 260Wh  
*LiPo-Accu, 260Wh*

Betriebsdauer: h bei voller Leistung  
*usage time: 8h on full power*

## vielseitig einsetzbar | versatile usable



Befestigung mittels Magnet  
*fastening with magnet*



Aufhängung für Gerüst & Geländer  
*suspension for scaffolding & railings*



Standfuß, verstellbar  
*stand, adjustable*



Praktisch stapelbar bei Lagerung  
*practically stackable when stored*



höhenverstellbares Stativ (1,38m - 2,50m)  
*(nur in Verbindung mit Standfuß anwendbar)*  
*height-adjustable tripod (1,38m - 2,50m) (can only be used in conjunction with a stand)*

## VORTEILE | ADVANTAGES

- lange Betriebszeit bei gleichzeitig hoher Lichtleistung
- geringes Gewicht von ca. 6kg
- vielseitiges Zubehör erhältlich
- *long operating time with high light output*
- *low weight of about 6kg*
- *various Accessories available*

## EINSATZBEREICHE | AREAS OF APPLICATION

- Inspektions- & Servicearbeiten
- Kanal- und Reinigungsarbeiten
- Lackierereien
- *inspection & service work*
- *sewer cleaning*

**++VORAUSSICHTLICH Q3/2024 VERFÜGBAR++**  
**++EXPECTED TO BE AVAILABLE IN Q3/2024++**

# ULTRAXL LED | ATEX AKKU LED STRAHLER | ATEX ACCU LED FLOODLIGHT



**ATEX AKKU LED Arbeitsstrahler mit blendfreiem Licht und extrem langer Betriebsdauer.**

- Leuchtmittel: 81 LEDs / 5000K
- Gehäuse: Kunststoff, antistatisch
- Frontglas: gehärtetes Glas mit Schutzfolie
- Diffusor: Diffusorfolie integriert
- Schutzart: IP65
- Betriebsdauer: 12h
- Akku: LiPo, 260 Wh
- Ladeinheit: 230V (ohne EX-Schutz)



**ATEX ACCU LED work lamp with glare-free light and extremely long usage time.**

- Illuminant: 81 LEDs / 5000K
- Housing: plastic, antistatic
- Front glass: tempered glass with protective film
- Diffusor: integrated diffuser film
- Protection category: IP65
- Usage time: 12h
- Battery: LiPo, 260 Wh
- Charging unit: 230V (not ex-proof)

## TECHNISCHE DATEN | TECHNICAL DATA

<b>Art.-Nr.   Art.-No.</b>	<b>290800</b>
Akku   Battery	260 Wh
Betriebsdauer   Usage time	12 h
Anzahl LED   Number LED	81
Nutzlicht   Real lumen	ca. 3200 Lm
Farbtemperatur   Color temperature	5000 K
Umgebungstemp.   Ambient temp.	-20°C - +45°C
IP Schutzart   IP protection class	IP65
Diffusor   Diffuser	ja   yes
Gehäuse   Housing	Kunststoff, antistatisch / plastic, antistatic
Frontglas   Front glass	gehärtetes Glas mit Schutzfolie / tempered glass with protective film
Schalter   On/Off switch	ja   yes
Ladeinheit   Charging unit	230V (ohne EX-Schutz   not ex-proof)
EX Schutzart   EX Protection	Ex ib IIC T4 Gb / Ex ib IIIC T135°C Db
Zonen   Zones	Zone 1, 2 / 21, 22
Temperaturklasse   Temperature class	T4 +T135°C

## ABMESSUNGEN | DIMENSIONS (IN MM)



a	b	c
388	147	319

### Gewicht | Weight

ca. 6 kg

## ZUBEHÖR | ACCESSORIES



EX-Magnethalterung  
EX-magnet bracket  
Art.-Nr. 290788



EX-Aufhängung  
EX-scaffolding hook  
Art.-Nr. 290764



EX-Standfuß  
EX subframe  
Art.-Nr. 290765



Edelstahl-Stativ  
tripod stainless steel  
Art.-Nr. 290789



Schutzfolie  
protective foil  
Art.-Nr. 290730



Tragekoffer  
carrying case  
Art.-Nr. 290769

# EX SLE 15 / SLE 16 | ATEX LED AKKU LEUCHTEN | ATEX LED ACCU LIGHTS

## Merkmale | Features



EX SLE 15 LED

EX SLE 16 LED



alle Modelle mit  
Notstromfunktion  
*all models with  
emergency function*

Fokus-Linse  
*focus lens*

schwenkbarer  
Leuchtenkopf  
*swiveling  
lamp head*



Blei-Gel - Akku, wartungsfrei  
*Lead gel - battery, maintance free*

EX SLE 15 LED - ohne Linsenfokus  
breite Ausleuchtung  
*EX SLE 15 LED - without lens focus  
wide illumination*

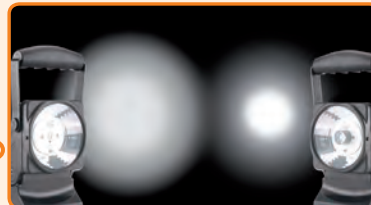

EX SLE 16 LED - mit Linsenfokus  
hohe Leuchtweite  
*EX SLE 16 LED - with lens focus  
high light range*



## VORTEILE | ADVANTAGES

- wahlweise mit oder ohne Fokus-Linse
- Ladeinheit für Wandmontage geeignet
- Notstromfunktion
- *optionally with or without focus lens*
- *charging unit suitable for wall mounting*
- *emergency power function*

## EINSATZBEREICHE | AREAS OF APPLICATION

- Rettungswesen & Katastrophenschutz
- Inspektions- und Servicearbeiten im EX-Bereich
- Kläranlagen, Biogasanlagen, Petrochemie
- *rescue & civil protection*
- *inspection and service work in EX areas*
- *sewage treatment plants, biogas plants, petrochemicals*





# EX SLE 15 / SLE 16 | ATEX LED AKKU LEUCHTEN | ATEX LED ACCU LIGHTS



## ATEX AKKU LED Arbeits- und Notstromleuchte. Im Set mit Ladestation und Zubehör.

- LED Handscheinwerfer: wiederaufladbar
- EX SLE 15 LED: breite, gleichmässige Ausleuchtung
- EX SLE 16 LED: mit Fokus-Linse für hohe Leuchtweite
- Gehäuse: Kunststoff
- Schutzart: IP64
- Akku: wartungsfreier Blei-Gel-Akku
- Notstromfunktion: schaltet sich bei Stromausfall ein
- Ladeinheit: Ladestation für Wandmontage geeignet



## ATEX ACCU LED work and emergency power light. In a set with charging station and Accessories.

- LED hand lamp: rechargeable
- EX SLE 15 LED: wide, homogeneous illumination
- EX SLE 16 LED: focus lense for wide headlight range
- Housing: plastic
- Protection category: IP64
- Battery: low-maintenance lead-gel accu
- Emergency function: in case of electrical power outage
- Charging unit: charging station suitable for wall mounting

### TECHNISCHE DATEN | TECHNICAL DATA

Typ   Type	EX SLE 15 LED	EX SLE 16 LED
Art.-Nr.   Art.-No.	290645	290646
Fokus Linse   Focus lens	nein   no	ja   yes
Leuchtweite   Headlight range	ca. 150m	ca. 170m
Hauptlampe   Main lamp	POWER LED	
Leuchtdauer   Duration	ca. 5h	
Pilotlampe   Pilot lamp	LED 5mm	
Leuchtdauer   Duration	ca. 85h	
IP Schutzart   IP protection class	IP64	
Gehäuse   Housing	Kunststoff / plastic	
Accu   Battery	Blei-Gel   lead gel - 3,7V / 4,6Ah	
Ladeinheit   Charging unit	230V / 12/24V (ohne EX-Schutz   not ex-proof)	
Maße/Gewicht   Dimen./Weight	104mm x 245mm x 72mm / 1,1kg	
EX Schutzart   EX Protection	EX II 2 G Ex ib IIC T4 Gb / EX II 2 D EX ib IICT135°C Db	
Zonen   Zones	Zone 1, 2 / 21, 22	
Prüfzertifikat   Test certificate	TÜV-A 07 ATEX 0001X	

### ABMESSUNGEN | DIMENSIONS (IN MM)



	Breite Width	Höhe Height	Tiefe Depth
SLE LED Leuchte   lamp	104	245	72
Ladestation   charging unit	104	125	63
Komplett   complete	104	245	120

#### im Lieferumfang enthalten included in the scope of delivery



- Ladestation | charging unit
- Vorsatzscheibe 2x | front lense 2x
- Ladekabel 230V | charging cable 230V
- Ladekabel 12/24V | charging cable 12/24V

# HL 30 EX / HL 35 EX LED | KNICKKOPFLEUCHE | FLEXIBLE HEAD LIGHT

## Merkmale | Features



HL 30 EX

HL 35 EX

Leuchtenkopf 180° schwenkbar  
luminaire head pivotable by 180°

Praktischer  
Drehschalter  
practical  
rotary switch

Ladestandsanzeige  
charge indicator

Li-Ionen Akku, austauschbar  
Li-ion battery, replaceable

einsetzbar in Zone 1, 2, 21,22  
usable in zone 1, 2, 21,22

ZONE 0/20

Schutzgummiring  
protective rubber ring

einsetzbar in Zone 0, 1, 2, 20, 21,22  
usable in zone 0, 1, 2, 20, 21,22



## VORTEILE | ADVANTAGES

- Leuchtenkopf 180° schwenkbar
- robustes, schlagfestes Gehäuse
- digitale Kapazitätsanzeige
- luminaire head pivotable by 180°
- robust, impact-resistant housing
- digital capacity display

## EINSATZBEREICHE | AREAS OF APPLICATION

- Rettungswesen / Katastrophenschutz / Feuerwehr
- Inspektions- und Servicearbeiten im EX-Bereich
- Kläranlagen, Biogasanlagen, Petrochemie
- rescue / civil protection / fire department
- inspection and service work in EX areas
- sewage treatment plants, biogas plants, petrochemicals

# HL 30 EX / HL 35 EX LED | KNICKKOPFLEUCHE | FLEXIBLE HEAD LIGHT



## ATEX AKKU LED Handscheinwerfer mit Digitalanzeige und 180° verstellbarem Leuchtenkopf.

- Gehäuse: Kunststoff, schlagfest
- Digitalanzeige: in Minuten- und Stundenangabe
- Schalter: praktischer Drehschalter
- Schutzart: IP67
- Leuchtenkopf: 180° verstellbar
- Akku: Li-Ionen 3,7V / 5Ah
- Ladeinheit: 230V & 12/24V (ohne EX-Schutz)



## ATEX ACCU LED hand lamp with digital display and 180° adjustable lamp head.

- Housing: Plastic, impact resistant
- Digital display: in minutes and hours
- Switch: practical rotary switch
- Protection category: IP67
- Lamp head: 180° adjustable
- Battery: Li-Ionen 3,7V / 5Ah
- Charging unit: 230V & 12/24V (not ex-proof)

### TECHNISCHE DATEN | TECHNICAL DATA

Typ   Type	HL 30 EX	HL 35 EX
Art-Nr.   Art-No.	290819	290787
Leuchtmittel   Illuminant	POWER LED   POWER LED	Hochleistungs-LED   high performance LED
Leuchtweite   Headlight range	ca. 180m	ca. 300m
Leuchtdauer   Duration	5h-300Lm / 10h-135Lm	10h-Fokus / 5h-Streu / 4h Fok.&Streu
IP Schutzart   IP protection	IP67	IP67
Gehäuse   Housing	Kunststoff   plastic	Kunststoff   plastic
Accu   Battery	Li-Ionen 3,7V / 5Ah	Li-Ionen 3,7V / 5Ah
Gewicht   Weight	ca. 600g	ca. 600g
Ladeinheit   Charging unit	230V / 12/24V	230V / 12/24V
EX Schutzart   EX Protection	II 2 G Ex ib IIC T4 Gb / II 2 D Ex ib IICT135°C Db	II 1 G Ex ia IIC T4 Ga / II 1 D Ex ia IICT135° Da
Zonen   Zones	Zone 1,2 / 21,22	Zone 0,1,2 / 20, 21,22
Prüfzertifikat   Test certificate	TÜV-A 20ATEX0001X	TÜV-A 19ATEX0002X

### ART-NR. | ART-NO.

	HL 30 EX	HL 35 EX
Set mit Ladestation und Anschlusskabel 230V & 12/24V   set with charging unit and cable 230V & 12/24V	290819	290787
Set mit Ladestation und Anschlusskabel 12/24V   set with charging unit and cable 12/24V	290818	290783
nur Leuchte   only lamp	290817	290784
nur Ladeinheit mit Anschlusskabel 230V   only charging unit and cable 230V	290634	290634
nur Ladeinheit mit Anschlusskabel 12/24V   only charging unit and cable 12/24V	290635	290635

### ABMESSUNGEN | DIMENSIONS (IN MM)



Ladestation enthalten  
charging station included



optional Mehrfach-Ladestation  
optional multiple charging station



# HL 12 EX | ATEX HANDLEUCHE | ATEX HAND LAMP

## Merkmale | Features



**HL 12 EX - Set**



inkl. Ladeinheit  
incl. charging unit

**ZONE 1 / 2**  
**ZONE 21/22**

Halteclip  
retaining clip

robustes  
Kunststoffgehäuse  
robust  
plastic housing

2 Leuchtstufen  
und Blinkmodus  
two brightness levels  
and flashing mode

**HL 12 EX  
Akku-Version**  
(nur Leuchte | only lamp)



**ZONE 0 / 20**

inkl. Li-Ion Akku 3,7V  
incl. Li-Ion battery 3,7V

**HL 12 EX  
Batterie-Version**  
(nur Leuchte | only lamp)



**ZONE 0 / 20**

inkl. 3x AA Batterie  
incl. 3x AA battery



## VORTEILE | ADVANTAGES

- als Akku oder Batterie Version erhältlich
- auch für Zone 0 geeignet (versionsabhängig)
- extrem leichtes Gewicht
- available as rechargeable battery or battery version
- also suitable for zone 0 (depending on version)
- extremely light weight

## EINSATZBEREICHE | AREAS OF APPLICATION

- Rettungswesen / Katastrophenschutz / Feuerwehr
- Inspektions- und Servicearbeiten im EX-Bereich
- Kläranlagen, Biogasanlagen, Petrochemie
- rescue / civil protection / fire department
- inspection and service work in EX areas
- sewage treatment plants, biogas plants, petrochemicals

# HL 12 EX | ATEX HANDLEUCHE | ATEX HAND LAMP



**EX-geschützte Handleuchte mit POWER LED in Winkelform - sehr hell und extrem leicht.**

- Gehäuse: Kunststoff
- Leuchtmittel: POWER LED
- Schalter: 2 Leuchtstufen & Blinklicht
- Schutzart: IP67
- Leuchtenkopf: 90° abgewinkelt (nicht verstellbar)
- Versionen: im Set mit Ladestation, oder Einzelleuchte als Akku oder Batterieausführung



**EX-protected hand lamp with POWER LED in angled shape - very bright and extremely light.**

- Housing: plastic
- Illuminant: POWER LED
- Switch: 2 brightness levels & flashing mode
- Protection category: IP67
- Lamp head: 90° angled (not adjustable)
- Versions: in a set with a charging station, or as a single lamp as a rechargeable battery or battery version

## TECHNISCHE DATEN | TECHNICAL DATA

Typ   Type	HL 12 EX
Leuchtmittel   Illuminant	POWER LED   POWER LED
Lumen   Lumen	170 Lm
Leuchtweite   Headlight range	ca. 200m
Leuchtdauer   Duration	ca. 5h
IP Schutzart   IP protection	IP67
Gehäuse   Housing	Kunststoff   plastic
Ladeeinheit   Charging unit	230V / 12/24V

## ZONE 1/2/21/22 VERSION

EX Schutzart   EX Protection	II 2 G Ex ib IIC T4 Gb / II 2 D Ex ib IIIC T135°C Db
Zonen   Zones	Zone 1,2 / 21,22
Prüfzertifikat   Test certificate	TÜV-A 16ATEX0003X

## ZONE 0/1/2/20/21/22 VERSION

EX Schutzart   EX Protection	II 1 G Ex ia IIC T4 Ga / II 1 D Ex ia IIIC T135°C Da
Zonen   Zones	Zone 0,1,2 / 20, 21,22
Prüfzertifikat   Test certificate	TÜV-A 16ATEX0003X

## ART-NR. | ART-NO.

HL 12 EX Set mit Ladestation 230V (Zone 1,2,21,22)   set with charging unit 230V (Zone 1,2,21,22)	290776
HL 12 EX Set mit Ladestation 12/24V (Zone 1,2,21,22)   set with charging unit 12/24V (Zone 1,2,21,22)	290775
HL 12 EX Zone 1,2,21,22 (nur Leuchte Akku-Version   only lamp rechargeable)	290774
HL 12 EX Zone 0,1,2,20,21,22 (nur Leuchte Akku-Version   only lamp rechargeable)	290777
HL 12 EX Zone 0,1,2,20,21,22 (nur Leuchte Batterie-Version   only lamp battery version)	290773
Ladestation 230V   charging Unit 230V	290634
Ladestation 12/24   charging Unit 12/24V	290635

## ABMESSUNGEN | DIMENSIONS (IN MM)



im Set Ladestation enthalten  
the set includes a charging station



optional Mehrfach-Ladestation  
optional multiple charging station



# LED ATEX TASCHENLAMPEN | LED ATEX TORCHES

## Merkmale | Features



HL 10 EX



ATEX-Nr.: TÜV-A 10ATEX0003

● II 2 G Ex ib IIC T4  
● II 2 D Ex ibD 21 T 135°C  
Zone: 1, 2 / 21, 22



### TECHNISCHE DATEN | TECHNICAL DATA

Art.-Nr.   Art.-No.	290771
Hauptlampe   Main lamp	POWER LED
Leuchtweite   Headlight range	ca. 150m
Lumen   Lumen	110 Lm
Leuchtdauer   Duration	ca. 11h
IP Schutzart   IP protection	IP68
Batterie   Battery	4x AA Mignon
Gehäuse   Housing	Kunststoff   plastic
Gewicht   Weight	167g
Abmessung   Dimension	172mm x 41mm

## Merkmale | Features



HL 10 EX W



ATEX-Nr.: TÜV-A 18ATEX0002X

● II 2 G Ex ib IIC T4 Gb  
Zone: 1, 2 / 21, 22



### TECHNISCHE DATEN | TECHNICAL DATA

Art.-Nr.   Art.-No.	290778
Hauptlampe   Main lamp	POWER LED
Leuchtweite   Headlight range	ca. 150m
Lumen   Lumen	170 Lm
Leuchtdauer   Duration	ca. 11h
IP Schutzart   IP protection	IP67
Batterie   Battery	4x AA Mignon
Gehäuse   Housing	Kunststoff   plastic
Gewicht   Weight	250g
Abmessung   Dimension	45 x 200 x 100 mm



# LED ATEX TASCHENLAMPEN | LED ATEX TORCHES

## Merkmale | Features



### MHL 5 EX



#### ATEX-Nr.: TÜV-A 13ATEX0004X

● II 2 G Ex ib IIC T4 Gb  
 ● II 2 D Ex ibD 21 T 135°C Db  
 Zone: 1, 2 / 21, 22



#### TECHNISCHE DATEN | TECHNICAL DATA

Art.-Nr.   Art.-No.	<b>290649</b>
Hauptlampe   Main lamp	POWER LED
Leuchtwerte   Headlight range	ca. 30m
Lumen   Lumen	42 Lm
Leuchtdauer   Duration	ca. 4h
IP Schutzart   IP protection	IP68
Batterie   Battery	4x AAA Micro
Gehäuse   Housing	Kunststoff   plastic
Gewicht   Weight	45g
Abmessung   Dimension	145mm x 20mm

## Merkmale | Features



### STL 1 EX



#### ATEX-Nr.: TÜV-A 18ATEX0002X

● II 1 G Ex ia IIC T4 Ga  
 Zone: 0 (alle Gase)



#### TECHNISCHE DATEN | TECHNICAL DATA

Art.-Nr.   Art.-No.	<b>290655</b>
Hauptlampe   Main lamp	CREE LED
Leuchtwerte   Headlight range	ca. 100m
Lumen   Lumen	170 Lm
Leuchtdauer   Duration	ca. 4h
IP Schutzart   IP protection	IP67
Batterie   Battery	3x AAA Micro
Gehäuse   Housing	Kunststoff   plastic
Gewicht   Weight	164g
Abmessung   Dimension	45 x 200 x 100 mm



# BEGRIFFE AUS DER LICHTTECHNIK...

## BELEUCHTUNGSSTÄRKE

Die Beleuchtungsstärke gibt an wie viel Licht auf eine bestimmte Fläche projiziert wird. Die Maßeinheit wird in Lux angegeben. Ein Lux beträgt ergibt sich wenn ein Lumen (Lichtstrom) eine Fläche von einem QM gleichmäßig ausleuchtet. Zur Ermittlung der Beleuchtungsstärke wird ein Luxmeter benötigt.

## CANDELA

Candela ist die Einheit der Lichtstärke (siehe auch Lichtstärke)

## DIFFUSORFOLIE

Eine Diffusorfolie ist eine für den Einsatz mit LED-Leuchtmitteln optimierte, lichtstreuende/lichtverteilende PC-Folie. Sie sorgt für eine homogene Streuung des punktförmigen Lichts von LEDs

## FARBTEMPERATUR

Die Farbtemperatur (Maßeinheit Kelvin (K)) beschreibt die Lichtfarbe (siehe Lichtfarbe) einer Lichtquelle. Charakteristische Lichtfarben sind: unter 3000K - warmweiß / 3300K - 6000K - neutralweiß / über 5000K - tageslichtweiß

## IP-SCHUTZARTEN

### Kennziffer 1 - Schutz gegen Fremdkörper

- 0 - kein Schutz
- 1 - Schutz gegen feste Fremdkörper mit  $\varnothing > 50\text{mm}$
- 2 - Schutz gegen feste Fremdkörper mit  $\varnothing > 12,5\text{mm}$
- 3 - Schutz gegen feste Fremdkörper mit  $\varnothing > 2,5\text{mm}$
- 4 - Schutz gegen feste Fremdkörper mit  $\varnothing > 1\text{mm}$
- 5 - Schutz gegen Staub (in schädigender Menge)
- 6 - staubdicht

### Kennziffer 2 - Schutz gegen Wasser

- 0 - kein Schutz
- 1 - Schutz gegen senkrecht tropfendes Wasser
- 2 - Schutz gegen fallendes Tropfwasser (bis zu 15% Neigung des Betriebsmittels)
- 3 - Schutz gegen Sprühwasser (bis 60° zur Senkrechten)
- 4 - Schutz gegen Spritzwasser (aus jeglicher Richtung)
- 5 - Schutz gegen Strahlwasser (beliebiger Winkel)
- 6 - Schutz gegen starkes Strahlwasser
- 7 - Schutz gegen zeitweiliges Untertauchen (max. 30min bei Wassertiefe 1 m)
- 8 - Schutz gegen andauerndes Untertauchen
- 9K - Schutz gegen sehr intensiven Wasserstrahl

## LED

LED steht als Abkürzung für Licht Emittierende Dioden (engl. Light Emitting Diodes). Hierbei handelt es sich um elektronische Halbleiter-Bauelemente, welche in verschiedenen Farben, Größen und Bauformen erhältlich sind. Durch anlegen von elektrischer Spannung kann Licht in unterschiedlichen Farben (Blau, Grün, Gelb oder Rot) erzeugt werden. Weißes Licht wird durch entsprechende Farbmischung erzeugt. Vorteile von LED-Beleuchtung sind u.a.: geringer Energieverbrauch, hohe Lebensdauer, hohe Farbstabilität, Erschütterungsunempfindlich, Wartungsfrei.

## LAMPE

Mit einer Lampe wird elektrische Energie in Licht umgewandelt, somit handelt es sich um eine künstliche Lichtquelle.

## LEUCHE

Als Leuchte wird die gesamte Einheit, sowie die dazugehörigen Komponenten, welche für den sicheren Betrieb der Lampe benötigt werden, bezeichnet. Umgangssprachlich wird die Leuchte oft als Lampe (siehe Lampe) bezeichnet.

## LICHTSTÄRKE

Die Lichtstärke wird in der Einheit Candela (cd) gemessen, und gibt an wie viel Lichtstrom auf einen bestimmten Raumwinkel entfällt. Die Lichtstärke von Glühbirnen verteilt sich nahezu in allen Richtungen und ist somit gleichförmig. LED Lampen hingegen strahlen nicht in alle Richtungen die gleiche Lichtstärke ab. Bei diesen Lampen ist die Lichtstärke nur in Zusammenhang mit dem entsprechenden Abstrahlwinkel aussagekräftig. Bei verschiedenen Abstrahlwinkeln und gleichem Lichtstrom (Lumen) ist die Lichtstärke bei der Leuchte mit dem kleineren Abstrahlwinkel höher.

## LUMEN

Lumen (Lm) bezeichnet die Einheit für den Lichtstrom. Durch den Lumenwert kann Rückschluss auf die Helligkeit einer Lichtquelle gezogen werden. Er gibt an wieviel Licht von der Lichtquelle in alle Richtungen abgestrahlt wird.

## LUX

Lux ist die Maßeinheit der Beleuchtungsstärke. (siehe Beleuchtungsstärke) . Diese gibt an wie viel Licht auf eine definierte Fläche fällt. Zur Messung der Beleuchtungsstärke wird ein Luxmeter benötigt.



# EXPLOSIONSSCHUTZ - GRUNDLAGEN UND BEGRIFFE...

## ATEX

ATEX steht als Synonym für die ATEX-Leitlinien der EU. Das Wort ATEX setzt sich zusammen aus der französischen Bezeichnung Atmosphère Explosibles

## EX-LEUCHTEN

ATEX bzw. EX Leuchten sind Betriebsmittel welche für Bereiche der Gas-EX- und Staub-EX Zonen entsprechend der ATEX Richtlinie 2014/34/EU zugelassen sind. Für welche ATEX Bereiche das jeweilige Betriebsmittel eingesetzt werden kann ergibt sich aus der ATEX Kennzeichnung welche i.d.R. auf dem Betriebsmittel angebracht ist.

## GERÄTEGRUPPE

**Gerätegruppe I:** gilt für Geräte zur Verwendung in Untertagebetrieben von Bergwerken sowie deren Übertageanlagen, die durch Grubengas und/oder brennbare Stäube gefährdet werden können.

**Gerätegruppe II:** gilt für Geräte zur Verwendung in den übrigen Bereichen, die durch eine explosionsfähige Atmosphäre gefährdet werden können.

## TEMPERATURKLASSEN

EX-Bereiche in denen ex-geschützte Betriebsmittel betrieben werden, werden in sechs Temperaturklassen eingeteilt. Die Temperaturklasse bezeichnet die max. zulässige Oberflächentemperatur, die bei +40° Umgebungstemperatur, an keiner Stelle und zu keinem Zeitpunkt an der Oberfläche des Betriebsmittel erreicht bzw. überschritten werden darf.

Klasse	Gemisch-Temperaturbereiche	Zündtemperatur von brennbaren Stoffen wie z.B.
T1	> 450°C	Propangas 510°C
T2	> 300°C - ≤ 450°C	Acetylen 305°C
T3	> 200°C - ≤ 300°C	Diesel 220°C - 300°C / Benzin 220°C - 450°C
T4	> 135°C - ≤ 200°C	Diethylether 170°C
T5	> 100°C - ≤ 135°C	
T6	> 85°C - ≤ 100°C	Schwefelkohlenstoff 85°C

## ZONENEINTEILUNG GAS / STAUB

**GAS ZONE 0 / KAT. 1G:** Bereich in dem explosionsfähige Atmosphäre als Gemisch aus Luft und brennbaren Gasen, Dämpfen oder Nebeln ständig, über lange Zeiträume oder häufig vorhanden ist.

**GAS ZONE 1 / KAT. 2G:** Bereich, in dem sich bei Normalbetrieb gelegentlich eine explosionsfähige Atmosphäre als Gemisch aus Luft und brennbaren Gasen, Dämpfen oder Nebeln bilden kann.

**GAS ZONE 2 / KAT. 3G:** Bereich, in dem bei Normalbetrieb eine explosionsfähige Atmosphäre als Gemisch aus Luft und brennbaren Gasen, Dämpfen oder Nebeln normalerweise nicht oder aber nur kurzzeitig auftritt.

**STAUB Zone 20 / Kat. 1D:** Bereich in dem explosionsfähige Atmosphäre als Gemisch aus Luft und brennbaren Gasen, Dämpfen oder Nebeln ständig, über lange Zeiträume oder häufig vorhanden ist.

**STAUB Zone 21 / Kat. 2D:** Bereich, in dem sich bei Normalbetrieb gelegentlich eine explosionsfähige Atmosphäre als Gemisch aus Luft und brennbaren Gasen, Dämpfen oder Nebeln bilden kann.

**STAUB Zone 22 / Kat. 3D:** Bereich, in dem bei Normalbetrieb eine explosionsfähige Atmosphäre als Gemisch aus Luft und brennbaren Gasen, Dämpfen oder Nebeln normalerweise nicht oder aber nur kurzzeitig auftritt.

## ZÜNDSCHUTZARTEN

### Elektrischer Explosionsschutz - Basisnorm Ex EN 60079-0

"d" = druckfeste Kapselung EN 60079-1

"p" = Überdruckkapselung EN 60079-2

"q" = Sandkapselung EN 60079-5

"o" = Ölkapselung EN 60079-6

"e" = erhöhte Sicherheit EN 60079-7

"i" = Eigensicherheit EN 60079-11

"m" = Vergußkapselung EN 60079-18

## ZÜNDPUNKT

Der Zündpunkt beziffert die niedrigste Temperatur, bei der brennbare Stoffe (Dämpfe, Gase, Stäube etc.) im richtigen Mischungsverhältnis mit Luft zu brennen beginnen.



# Zonen - Einteilung

## Gase & Dämpfe

Explosionsgefährdete Atmosphären sind nach der Wahrscheinlichkeit ihres Auftretens in Zonen eingeteilt. Die Zonen werden gemäß den Ex Richtlinien wie folgt definiert:

### ZONE 0

Bereich, in dem gefährliche explosionsfähige Gasatmosphäre ständig, langfristig oder häufig vorhanden ist. In der Regel liegen diese Bedingungen im Inneren von Behältern, Rohrleitungen, Apparaturen und Tanks vor.

### ZONE 1

Bereich, in dem damit zu rechnen ist, dass gefährliche explosionsfähige Gasatmosphäre bei normalem Betrieb gelegentlich auftritt. Hierzu gehört die nähere Umgebung der Zone 0 sowie nähere Bereiche um Füll- und Entleerungseinrichtungen.

### ZONE 2

Bereich, in dem nicht damit zu rechnen ist, dass bei normalem Betrieb gefährliche explosionsfähige Gasatmosphäre auftritt, und wenn sie dennoch auftritt, dann nur kurzzeitig. Zur Zone 2 gehören Lagerräume, wenn sie nur zum Lagern verwendet werden, Bereiche um lösbare Verbindungen von Rohrleitungen und in der Regel die nähere Umgebung der Zone 1

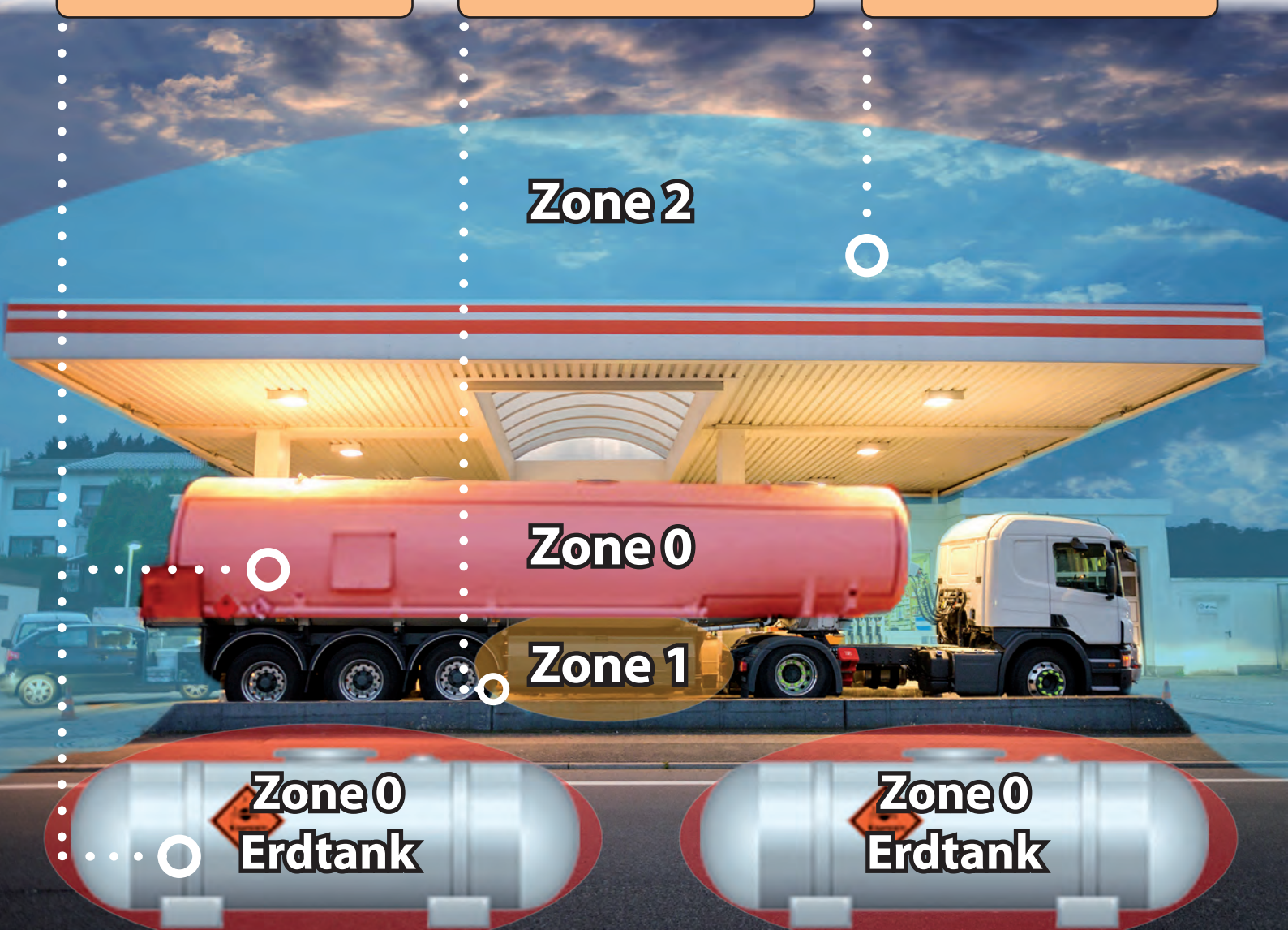

**Zone 2**

**Zone 0**

**Zone 1**

**Zone 0  
Erdtank**

**Zone 0  
Erdtank**



# LIEFER- UND ZAHLUNGSKONDITIONEN | DELIVERY AND PAYMENT TERMS



## **Liefer- und Zahlungskonditionen - innerhalb Deutschland**

Versand- inkl. Verpackungskosten: pauschal 9,00 €  
ab 450,00 € (netto) Auftragswert versandkostenfrei  
(ausgenommen Sendungen mit Zuschlägen, wie z.B. Express, Überlänge,  
Paletten, Versand, Insellieferungen)  
Zahlung: Vorkasse (sofern nicht anderweitig vereinbart)  
Bei Vorkasse: Zahlung per Überweisung nach Erhalt der Pro-Forma Rechnung.

## **Liefer- und Zahlungskonditionen – gültig europäisches Ausland**

Ab Werk Gottmadingen (EXW Gottmadingen) / Versandkosten werden in voller Höhe volumenabhängig berechnet.  
Zahlung: Vorkasse (sofern nicht anderweitig vereinbart)  
Bei Vorkasse: Zahlung per Überweisung nach Erhalt der Pro-Forma Rechnung.

## **Liefer- und Zahlungskonditionen – gültig restliche Welt**

Ab Werk Gottmadingen (EXW Gottmadingen) / Versandkosten werden in voller Höhe volumenabhängig berechnet. (Ausnahme: Versand / Abholung wird durch Kunde organisiert.) Zusätzlich erheben wir eine Bearbeitungsgebühr in Höhe von 90,-- € für die Erstellung von Exportdokumenten. Bei Notwendigkeit einer Legalisierung der Export- Dokumente durch die jeweilige Botschaft entstehen zusätzliche Kosten. Diese Kosten sind variabel und stehen in Abhängigkeit des Auftragswertes. Die Kosten werden in voller Höhe in Rechnung gestellt.  
Zahlung: Vorkasse (sofern nicht anderweitig vereinbart)  
Bei Vorkasse: Zahlung per Überweisung nach Erhalt der Pro-Forma Rechnung.

## **Verkaufs- und Lieferbedingungen**

Unser Angebot richtet sich ausschliesslich an gewerbliche Kunden (B2B), sowie öffentliche Auftraggeber. Alle in der Preisliste aufgeführten Preise verstehen sich zzgl. der derzeit gültigen Mehrwertsteuer.  
Es gelten unsere allgemeinen Liefer- und Verkaufsbedingungen.  
Die vollständigen Bedingungen sind abrufbar über [www.kira-leuchten.de/de/agb](http://www.kira-leuchten.de/de/agb). Entsorgung von Elektro-Altgeräten: WEEE-Reg. Nr. DE 76655398. Technische und inhaltliche Änderungen, Irrtümer und Druckfehler vorbehalten.

Stand: 01.04.2024



## **Delivery and payment conditions - within Germany**

Shipping including packaging costs: flat rate €9.00  
Free shipping for orders over €450.00 (net).  
(excluding shipments with surcharges, such as express, excess length,  
pallets, shipping, island deliveries)  
Payment: Payment in advance (unless otherwise agreed)  
For advance payment: Payment by bank transfer after receipt of the pro forma invoice.

## **Delivery and payment conditions – valid in other European countries**

Ex works Gottmadingen (EXW Gottmadingen) / Shipping costs are calculated in full depending on the volume.  
Payment: Payment in advance (unless otherwise agreed)  
For advance payment: Payment by bank transfer after receipt of the pro forma invoice.

## **Delivery and payment conditions – valid rest of the world**

Ex works Gottmadingen (EXW Gottmadingen) / Shipping costs are calculated in full depending on the volume. (Exception: shipping/collection is organized by the customer.) We also charge a processing fee of €90 for the creation of export documents. If the export documents need to be legalized by the respective embassy, additional costs will arise. These costs are variable and depend on the order value. The costs will be invoiced in full.  
Payment: Payment in advance (unless otherwise agreed)  
For advance payment: Payment by bank transfer after receipt of the pro forma invoice.

## **Conditions of sale and delivery**

Our offer is aimed exclusively at commercial customers (B2B) and public clients. All prices listed in the price list do not include the currently applicable VAT. Our general delivery and sales conditions apply. The complete conditions are available at [www.kira-leuchte.de/de/agb](http://www.kira-leuchte.de/de/agb). Disposal of old electrical devices: WEEE Reg.No. DE 76655398. Technical and content changes, errors and subject to printing errors.

As of: April 1, 2024

## IMPRESSUM

Ausgabe: April 2024

Herausgeber KIRA Leuchten GmbH

Copyright KIRA Leuchten GmbH

Redaktion: Kai Höller / Guntram Brütsch

Sortiment freibleibend, keine Haftung bei Irrtümern und Druckfehlern. Produktänderungen behalten wir uns, insbesondere bei technischen Weiterentwicklungen und Modellwechseln vor. Die Originalware kann von den im Katalog verwendeten Bildern abweichen, daß gilt ebenso für Farbabweichungen, die drucktechnisch unvermeidbar sind. Dieser Katalog, sowie das für den Katalog verwendete Bildmaterial ist urheberrechtlich geschützt. Die Vervielfältigung, Bearbeitung, Verbreitung und jede Art der Verwertung außerhalb der Grenzen des Urheberrechtes bedürfen der schriftlichen Zustimmung des jeweiligen Autors, Erstellers bzw. der KIRA Leuchten GmbH erfolgen. Insbesondere werden Inhalte Dritter über den nachfolgenden Bildquellennachweis als solche gekennzeichnet.

### Bildquellennachweis

Katalogseite 1: "Gasoline tanker, Oil trailer, truck on" © chagpg - stock.adobe.com / "Factory, Industry, Oil Refinery" © TTstudio - stock.adobe.com / "Standbohrmaschine im Betrieb, Detail" © martinseb - stock.adobe.com | Katalogseite 5: "Automechaniker // Mechanic in car..." © industrieblick - stock.adobe.com / "A large tanker repairs in dry dock" © Nightman1965 - stock.adobe.com / "Column tower in petrochemical plant..." © mmmx - stock.adobe.com / "Clear blue water wave on white background" © New Africa - stock.adobe.com / "IP68 Proof Shield illustration" © vector\_master - stock.adobe.com / "Einsatzfahrzeug mit Equipment" © Dr. N. Lange - Fotolia.com / "Pasteurisationsanlage" © werbefoto-burger.ch - stock.adobe.com / "Electric passenger train. Very fast driving. journey and t..." © chagpg - Fotolia.com | Katalogseite 6: "Automechaniker // Mechanic in car..." © industrieblick - stock.adobe.com | Katalogseite 7: "Mechanic inspecting a lifted car" © Minerva Studio - stock.adobe.com | Katalogseite 10 & 16: "Clear blue water wave on white background" © New Africa - Fotolia.com / "IP68 Proof Shield illustration" © vector\_master - stock.adobe.com | Katalogseite 12: "equipment on wooden desk with man working in workshop background. Vintage tone Retro filter effect." © MIND AND I - stock.adobe.com | Katalogseite 14: "Mechanic inspecting a lifted car" © Minerva Studio - stock.adobe.com | Katalogseite 18: "Subway tunnel. Kiev, Ukraine. Kyiv, Ukraine" © Oleg Totskiy - stock.adobe.com | Katalogseite 21: "printing shop industry interiors - machines for transport and packaging" © industrieblick - stock.adobe.com / "Gebäudetechnik" © werbefoto-burger.ch - stock.adobe.com / "printing shop industry interiors - machines for transport and packaging" © industrieblick - stock.adobe.com / "Pasteurisationsanlage" © werbefoto-burger.ch - stock.adobe.com / "Car in garage" © DedMityay - stock.adobe.com / "Einsatzfahrzeug mit Equipment" © Dr. N. Lange - Fotolia.com / "Subway tunnel. Kiev, Ukraine. Kyiv, Ukraine" © Oleg Totskiy - stock.adobe.com / "Vertical cnc machine" © Александр Ивасенко - stock.adobe.com | Katalogseite 22: "Electrical terminal box. Control panel with magnetic contactor and overload relay. Checking cartridge fuse on main distribution board." © НИКCOА - stock.adobe.com | Katalogseite 24: "schaltschrank schütze steuerung sps schutzschalter leitungsschutz fi siemens schneider electric schalttafel sicherungsschrank" © mrdeeds - stock.adobe.com | Katalogseite 26: "Electric light lamp in industrial enclosure, power distribution industry." © cge2010 - stock.adobe.com | Katalogseite 28: "Industrie - Mechanik - Collage" © motorradcbr - stock.adobe.com | Katalogseite 28: "Industrie - Mechanik - Collage" © motorradcbr - stock.adobe.com | Katalogseite 30: "Car in garage" © DedMityay - stock.adobe.com | Katalogseite 32: "Air Handling Unit , (heating ventilating and air-conditioning system)" © Anucha - stock.adobe.com | Katalogseite 34: "Electrical switchgear room,Industrial electrical switch panel." © ETAJOE - stock.adobe.com | Katalogseite 36: "The Beskid tunnel. New railway tunnel in Carpathian mountains, Ukraine" © Oleg Totskiy - stock.adobe.com | Katalogseite 38: "The Beskid tunnel. New railway tunnel in Carpathian mountains, Ukraine" © Oleg Totskiy - stock.adobe.com | Katalogseite 40: "Room Painting Job" © Tomasz Zajda - stock.adobe.com | Katalogseite 43: "Industriearbeiter stellt Maschine in HiTech Fabrik ein" © industrieblick - stock.adobe.com / "A male chemist holds test tube of glass in his hand" © Hanna - Fotolia.com / "Lüftermessung" © rupbilder - stock.adobe.com / "Standbohrmaschine im Betrieb, Detail" © martinseb - stock.adobe.com / "equipment on wooden desk with man working in works..." © MIND AND I - stock.adobe.com | Katalogseite 44: "Manufacturing professional lathe machine. Industrial concept. Programmable modern digital lathe with digital program control, turret type blade" © Aleksandr Matveev - stock.adobe.com | Katalogseite 46: "Workers in the shop wear orange work clothes and wear glasses to prevent metal chips from penetrating. Stand beside the drilling rig and use metal drills in industrial" - stock.adobe.com | Katalogseite 48: "Worker in a factory" © olly - stock.adobe.com | Katalogseite 50: "Turner worker working on old lathe machine at factory" © primipil - stock.adobe.com | Katalogseite 52: "LED" © BRN-Pixel - stock.adobe.com | Katalogseite 53: "Moderner Busbahnhof auf dem Land - Bus Stop in the Countryside" © Petair - stock.adobe.com / "Hafen in Hamburg" © Marco2811 - stock.adobe.com / "Kohlekraftwerk Niederlaussem" © Markus - stock.adobe.com / "Einsatzfahrzeug mit Equipment" © Dr. N. Lange - Fotolia.com / "Electric passenger train. Very fast driving. journey and t..." © chagpg - Fotolia.com / "Notarzt" © Comofoto - stock.adobe.com | Katalogseite 54: "Moderner Busbahnhof auf dem Land - Bus Stop in the Countryside" © Petair - stock.adobe.com | Katalogseite 57: "Aerial view to sewage treatment plant in green fields. Grey water recycling. Waste management for 165, 000 inhabitants of Pilsen city in Czech Republic" © Kletr - stock.adobe.com / "Tankreinigung" © danielkoke - stock.adobe.com / "View of the quay shipyard at sunrise in Gdansk, Poland." © Nightman1965 - stock.adobe.com / "Einsatzfahrzeug mit Equipment" © Dr. N. Lange - Fotolia.com / "Passenger plane in the hangar." © dmitrimaruta - Fotolia.com / "Biogasanlage im Rapsfeld" © Jürgen Falchle - Fotolia.com / "Oil and gas platform with gas burning, Power energy" © currahee\_shutter - stock.adobe.com | Katalogseite 58: "inspecting the wings" © auremar - stock.adobe.com | Katalogseite 60: "Maintenance and repair of aircraft in the aviation hangar of the airport, view of a wide panorama." © aapsky - stock.adobe.com | Katalogseite 62: "Grain Silos in Corn Field" © Bits and Splits - stock.adobe.com | Katalogseite 64: "Oil pump jack work on oilfield petroleum extraction" © Photocreo Bednarek - stock.adobe.com | Katalogseite 66: "Tankreinigung" © danielkoke - stock.adobe.com | Katalogseite 66: "Tankreinigung" © danielkoke - stock.adobe.com | Katalogseite 68: "Factory, Industry, Oil Refinery" © TTstudio - stock.adobe.com | Katalogseite 71: "Aerial view to sewage treatment plant in green fields. Grey water recycling. Waste management for 165, 000 inhabitants of Pilsen city in Czech Republic" © Kletr - stock.adobe.com / "Gasoline tanker, Oil trailer, truck on" © chagpg - stock.adobe.com / "View of the quay shipyard at sunrise in Gdansk, Poland." © Nightman1965 - stock.adobe.com / "Factory, Industry, Oil Refinery" © TTstudio - stock.adobe.com / "Labor Raum Forschung Entwicklung Untersuchung Hospital" © sebastianreuter - stock.adobe.com / "Vertical cnc machine" © Александр Ивасенко - stock.adobe.com / "Oil and gas platform with gas burning, Power energy" © currahee\_shutter - stock.adobe.com | Katalogseite 72: "gas-tank truck goes on highway" © Yuri Bizgaimer - stock.adobe.com | Katalogseite 74: "White oil and gas refinery storage tank petrochemical architecture plant industrial, Oil refinery plant from industry zone business power and energy" © Kalyakan - stock.adobe.com | Katalogseite 76: "Equipment for pumping fuel on a fuel tanker truck" © scharfsinn86 - stock.adobe.com | Katalogseite 78: "Milk tanker truck pumps products into steel storage tanks, dairy factory industry" © Parilov - stock.adobe.com | Katalogseite 80: "Aerial night view of modern wastewater treatment plant with round pools for cleaning sewage, drone shot." © DedMityay - stock.adobe.com | Katalogseite 83: "Aerial view to sewage treatment plant in green fields. Grey water recycling. Waste management for 165, 000 inhabitants of Pilsen city in Czech Republic" © Kletr - stock.adobe.com / "View of the quay shipyard at sunrise in Gdansk, Poland." © Nightman1965 - stock.adobe.com / "Tankreinigung" © danielkoke - stock.adobe.com / "Factory, Industry, Oil Refinery" © TTstudio - stock.adobe.com / "large factory fire" © burnstuff2003 - stock.adobe.com / "Einsatzfahrzeug mit Equipment" © Dr. N. Lange - Fotolia.com / "Oil and gas platform with gas burning, Power energy" © currahee\_shutter - stock.adobe.com | Katalogseite 84: "Factory, Industry, Oil Refinery" © TTstudio - stock.adobe.com | Katalogseite 86: "Pumping water from sewage canals during the construction of roads in the city. Truck with orange water tank" © aapsky - stock.adobe.com | Katalogseite 88: "large factory fire" © burnstuff2003 - stock.adobe.com | Katalogseite 90: "Feuerauto" © Jennewein Photo - stock.adobe.com | Katalogseite 96: "Tanklaster Tankwagen an Tankstelle - Tank Truck at Gas Station" © Petair - stock.adobe.com



- ✓ **ATEX Beleuchtung**
- ✓ **Handleuchten**
- ✓ **Rohrleuchten**
- ✓ **Akku-Leuchten**



- ✓ **ATEX lighting**
- ✓ **Hand lamps**
- ✓ **Tube luminaires**
- ✓ **Battery lamps**



## **KIRA Leuchten GmbH**

Wiedenstraße 6  
D-78244 Gottmadingen

Telefon: +49 (0) 77 34 / 936 93 - 0  
Telefax: +49 (0) 77 34 / 936 93 - 29

E-Mail: [info@kira-leuchten.de](mailto:info@kira-leuchten.de)  
Internet: [www.kira-leuchten.de](http://www.kira-leuchten.de)

**[www.kira-leuchten.de](http://www.kira-leuchten.de)**